

November 2009

# GARAGE DOOR

## PRICE LIST

UP AND OVER DOORS	2-11
PREMIERE STEEL	2-6
ABS	6-7
TIMBER	8-9
GRP	10-11
g60 SECTIONAL DOORS	12-13
INSULATED ROLLER DOORS	14-15
ROLLER DOORS	16
REMOTE CONTROL SYSTEMS	17
TECHNICAL INFORMATION	18-26
GUARANTEES	27
ORDERING NOTES	28

**HENDERSON**  
GARAGE DOORS

# PREMIERE PAINTED STEEL DOORS

STANDARD SINGLE SIZES - Door prices shown are for Primed finish

		MERLIN		REGENT		DORIC II		LUMLEY		MINSTER		WARKWORTH		CORINTHIAN		REGENT CHEVRON II	
		W C 4 F		W C 4 F		W C 4 F		W C 4 F		W C 4 F V		W C 4 F		W C 4 F V		W C 4 F	
WIDTH METRIC	x HEIGHT IMPERIAL	CANOPY		TRACKED		CANOPY		TRACKED		CANOPY		TRACKED		CANOPY		TRACKED	
		1930 x 2134	6'4" x 7'	423	463	493	533	626	666	493	533	664	704	-	-	626	666
1981 x 1981	6'6" x 6'6"	417	457	478	518	626	666	478	518	664	704	-	-	626	666	-	-
1981 x 2134	6'6" x 7'	432	472	479	519	645	685	479	519	679	719	-	-	645	685	-	-
2083 x 1905	6'10" x 6'3"	447	-	508	-	-	-	508	-	646	-	-	-	601	-	-	-
2083 x 1930	6'10" x 6'4"	447	487	508	548	616	656	508	548	646	686	-	-	601	641	-	-
2083 x 1956	6'10" x 6'5"	447	487	508	548	616	656	508	548	646	686	-	-	601	641	-	-
2083 x 1981	6'10" x 6'6"	455	495	508	548	616	656	508	548	668	708	-	-	616	656	-	-
2083 x 2057	6'10" x 6'9"	465	505	519	559	627	667	519	559	670	710	-	-	627	667	-	-
2083 x 2134	6'10" x 7'	467	507	521	561	633	673	521	561	674	714	-	-	633	673	-	-
2108 x 1981	6'11" x 6'6"	465	505	519	559	627	667	519	559	670	710	-	-	627	667	-	-
2108 x 2057	6'11" x 6'9"	467	507	521	561	633	673	521	561	674	714	-	-	633	673	-	-
2108 x 2134	6'11" x 7'	469	509	525	565	636	676	525	565	676	716	-	-	636	676	-	-
2134 x 1829	7' x 6'	437	-	500	-	-	-	500	-	-	-	-	-	-	-	-	-
2134 x 1880	7' x 6'2"	439	-	499	-	-	-	499	-	-	-	-	-	-	-	-	-
2134 x 1905	7' x 6'3"	441	-	501	-	-	-	501	-	646	-	-	-	601	-	-	-
2134 x 1930	7' x 6'4"	441	481	501	541	601	641	501	541	646	686	-	-	601	641	-	-
2134 x 1956	7' x 6'5"	441	481	501	541	601	641	501	541	646	686	-	-	601	641	-	-
2134 x 1981	7' x 6'6"	392	432	477	517	588	628	477	517	639	679	824	864	588	628	495	535
2134 x 2057	7' x 6'9"	455	495	500	540	626	666	500	540	656	696	-	-	626	666	-	-
2134 x 2134	7' x 7'	449	489	495	535	622	662	495	535	656	696	833	873	622	662	522	562
2210 x 1930	7'3" x 6'4"	465	505	534	574	686	726	534	574	758	798	-	-	686	726	-	-
2210 x 1981	7'3" x 6'6"	479	519	544	584	697	737	534	574	758	798	-	-	697	737	-	-
2210 x 2134	7'3" x 7'	479	519	544	584	697	737	544	584	758	798	-	-	697	737	-	-
2261 x 1981	7'5" x 6'6"	479	519	544	584	697	737	544	584	732	772	-	-	697	737	-	-
2261 x 2134	7'5" x 7'	545	585	602	642	824	864	602	642	868	908	-	-	824	864	-	-
2286 x 1829	7'6" x 6'0"	467	-	510	-	-	-	510	-	-	-	-	-	-	-	-	-
2286 x 1880	7'6" x 6'2"	482	-	535	-	-	-	535	-	-	772	-	-	-	-	-	-
2286 x 1905	7'6" x 6'3"	468	-	518	-	-	-	518	-	726	766	-	-	668	-	-	-
2286 x 1930	7'6" x 6'4"	468	508	519	559	669	709	519	559	732	772	-	-	669	709	-	-
2286 x 1981	7'6" x 6'6"	466	506	519	559	669	709	519	559	732	-	863	903	669	709	552	592
2286 x 2134	7'6" x 7'	534	574	583	623	796	836	583	623	868	-	868	908	796	836	612	652
2438 x 1905	8'0" x 6'3"	520	-	601	-	-	-	601	-	874	-	-	-	828	-	-	-
2438 x 1930	8'0" x 6'4"	539	579	615	655	831	871	615	655	882	922	-	-	831	871	-	-
2438 x 1981	8'0" x 6'6"	539	579	615	655	831	871	615	655	882	922	-	-	831	871	-	-
2438 x 2134	8'0" x 7'	552	592	704	744	868	908	704	744	918	958	-	-	868	908	-	-

Door prices shown are for Primed finish.

## OPTIONS AVAILABLE - PAINTED STEEL DOORS

### W FULLY FINISHED DEEP TEXTURED WHITE

- For single doors Add £59
- For double doors Add £90

Note: This door finish does NOT require overpainting.

### C FULLY FINISHED DEEP TEXTURED COLOURS

- For single doors Add £85
- For double doors Add £133

Colours available: Monarch Red - Balmoral Green - Conker Brown - Ebony Black - Oxford Blue - Metallic Grey - Mushroom Grey - White. These doors do NOT require overpainting

Note: All doors painted inside and out to chosen colour.

### 4 FOUR POINT LOCKING

To convert existing 2 point locking system to 4 point locking (Kit supplied)

- For single doors Add £26
- For double doors Add £41

# PREMIERE PAINTED STEEL DOORS

STANDARD DOUBLE SIZES - Door prices shown are for Primed finish

		MERCURY		REGENT		CORINTHIAN		MINSTER	
		MERCURY		REGENT		CORINTHIAN		MINSTER	
		W C 4 F		W C 4 F		W C 4 F V		W C 4 F V	
OPTIONS									
WIDTH METRIC	x HEIGHT IMPERIAL	CANOPY	TRACKED	CANOPY	TRACKED	CANOPY	TRACKED	CANOPY	TRACKED
2591 x 1981 / 2134	8'6" x 6'6" / 7'	-	623	-	843	-	1009	-	1014
2743 x 1981 / 2134	9' x 6'6" / 7'	-	830	-	914	-	1150	-	1161
3048 x 1981 / 2134	10' x 6'6" / 7'	-	1199	-	1268	-	1370	-	1568
3353 x 1981 / 2134	11' x 6'6" / 7'	-	1291	-	1354	-	1456	-	1628
3658 x 1981 / 2134	12' x 6'6" / 7'	-	1370	-	1437	-	1603	-	1760
3962 x 1981 / 2134	13' x 6'6" / 7'	-	1427	-	1504	-	1760	-	1917
4242 x 1981 / 2134	13'11" x 6'6" / 7'	-	1436	-	1507	-	1772	-	1934
4267 x 1981 / 2134	14' x 6'6" / 7'	-	1378	-	1378	-	1724	-	1868
4420 x 1981 / 2134	14'6" x 6'6" / 7'	-	1674	-	1654	-	1958	-	1958
4572 x 1981 / 2134	15' x 6'6" / 7'	-	-	-	1693	-	2081	-	2081
4877 x 1981 / 2134	16' x 6'6" / 7'	-	-	-	1879	-	2204	-	2204

Door prices shown are for Primed finish.

		DORIC II		REGENT CHEVRON II		LUMLEY		WARKWORTH	
		DORIC II		REGENT CHEVRON II		LUMLEY		WARKWORTH	
		W C 4 F		W C 4 F		W C 4 F		W C 4 F	
OPTIONS									
WIDTH METRIC	x HEIGHT IMPERIAL	CANOPY	TRACKED	CANOPY	TRACKED	CANOPY	TRACKED	CANOPY	TRACKED
2591 x 1981 / 2134	8'6" x 6'6" / 7'	-	1009	-	-	-	843	-	-
2743 x 1981 / 2134	9' x 6'6" / 7'	-	1150	-	-	-	989	-	-
3048 x 1981 / 2134	10' x 6'6" / 7'	-	1370	-	-	-	1268	-	-
3353 x 1981 / 2134	11' x 6'6" / 7'	-	1456	-	-	-	1275	-	-
3658 x 1981 / 2134	12' x 6'6" / 7'	-	1603	-	-	-	1437	-	-
3962 x 1981 / 2134	13' x 6'6" / 7'	-	1760	-	-	-	1504	-	-
4242 x 1981 / 2134	13'11" x 6'6" / 7'	-	1736	-	-	-	1507	-	-
4267 x 1981 / 2134	14' x 6'6" / 7'	-	1724	-	1496	-	1378	-	1895
4420 x 1981 / 2134	14'6" x 6'6" / 7'	-	1958	-	-	-	-	-	-
4572 x 1981 / 2134	15' x 6'6" / 7'	-	2081	-	-	-	-	-	-
4877 x 1981 / 2134	16' x 6'6" / 7'	-	2204	-	-	-	-	-	-

Door prices shown are for Primed finish.

## SIDE HINGED PAINTED STEEL DOORS

STANDARD SIZES

		KING		REGENT	
		KING		REGENT	
		50mm frame as standard		50mm frame as standard	
		W H C		W H C	
WIDTH METRIC	x HEIGHT IMPERIAL	SIDE HINGED		SIDE HINGED	
2134 x 1981	7'0" x 6'6"	699		699	
2134 x 2134	7'0" x 7'0"	699		699	

Door prices shown are for Primed finish.

### F FRAMED DOORS

- For single doors Add **£95**
- For double doors Add **£170**

Choose either:

Standard width frame (68mm jamb) or Narrow width frame (canopy gear only, 54mm jamb)

Frames supplied to match the door finish. Doors can be supplied with a white finished frame on request.

### V VISION WINDOWS

- For single doors Add **£114**
- For double doors Add **£191**

- H** ● Left hand opening Add **£55**

# PREMIERE PAINTED STEEL DOORS

MADE TO MEASURE SIZES - Door prices shown are for Primed finish

WIDTH x HEIGHT		CANOPY		TRACKED		CANOPY		TRACKED		CANOPY		TRACKED		CANOPY		TRACKED	
METRIC	IMPERIAL																
1981 x 1981/2134	6'6" x 6'6" / 7'0"	597	637	721	761	886	926	721	741	927	967	-	-	886	926	-	-
2134 x 1981/2134	7' x 6'6" / 7'0"	597	637	721	761	886	926	721	741	927	967	-	-	886	926	-	-
2286 x 1981/2134	7'6" x 6'6" / 7'0"	641	681	762	802	962	1002	762	802	1008	1048	-	-	962	1002	-	-
2438 x 1981/2134	8' x 6'6" / 7'0"	721	761	851	891	1155	1195	851	891	1221	1261	-	-	1155	1195	-	-
2591 x 1981/2134	8'6" x 6'6" / 7'0"	-	900	-	1041	-	1381	-	1003	-	1445	-	-	-	1381	-	-
2743 x 1981/2134	9' x 6'6" / 7'0"	-	1037	-	1156	-	1575	-	1112	-	1650	-	-	-	1575	-	-
3048 x 1981/2134	10' x 6'6" / 7'0"	-	1333	-	1437	-	1890	-	1377	-	1985	-	-	-	1890	-	-
3353 x 1981/2134	11' x 6'6" / 7'0"	-	1403	-	1517	-	1985	-	1462	-	2082	-	-	-	1985	-	-
3658 x 1981/2134	12' x 6'6" / 7'0"	-	1490	-	1609	-	2082	-	1550	-	2182	-	-	-	2082	-	-
3962 x 1981/2134	13' x 6'6" / 7'0"	-	1579	-	1707	-	2234	-	1643	-	2298	-	-	-	2234	-	-
4267 x 1981/2134	14' x 6'6" / 7'0"	-	1672	-	1814	-	2298	-	1747	-	2410	-	-	-	2298	-	-
4572 x 1981/2134	15' x 6'6" / 7'0"	-	-	-	1921	-	2410	-	-	-	2530	-	-	-	2410	-	-
4877 x 1981/2134	16' x 6'6" / 7'0"	-	-	-	2031	-	2530	-	-	-	2730	-	-	-	2530	-	-
1981 x 2286	6'6" x 7'6"	-	676	-	801	-	-	-	-	-	1015	-	-	-	968	-	-
2134 x 2286	7' x 7'6"	-	708	-	828	-	-	-	-	-	1045	-	-	-	997	-	-
2286 x 2286	7'6" x 7'6"	-	784	-	899	-	-	-	-	-	1155	-	-	-	1091	-	-
2438 x 2286	8' x 7'6"	-	820	-	982	-	-	-	-	-	1362	-	-	-	1301	-	-
2591 x 2286	8'6" x 7'6"	-	970	-	1096	-	-	-	-	-	1554	-	-	-	1486	-	-
2743 x 2286	9' x 7'6"	-	1112	-	1200	-	-	-	-	-	1773	-	-	-	1699	-	-
3048 x 2286	10' x 7'6"	-	1437	-	1495	-	-	-	-	-	2142	-	-	-	2041	-	-
3353 x 2286	11' x 7'6"	-	1517	-	1580	-	-	-	-	-	2249	-	-	-	2142	-	-
3658 x 2286	12' x 7'6"	-	1609	-	1678	-	-	-	-	-	2364	-	-	-	2249	-	-
3962 x 2286	13' x 7'6"	-	1707	-	1774	-	-	-	-	-	2482	-	-	-	2363	-	-
4267 x 2286	14' x 7'6"	-	1814	-	1886	-	-	-	-	-	2606	-	-	-	2482	-	-
4572 x 2286	15' x 7'6"	-	-	-	1994	-	-	-	-	-	2746	-	-	-	2606	-	-
4877 x 2286	16' x 7'6"	-	-	-	2111	-	-	-	-	-	2868	-	-	-	2732	-	-

Door prices shown are for Primed finish.

## MADE TO MEASURE PRICING

**Sizing:** Sizes shown for garage doors refer to inner frame dimensions. To measure for a garage door, use the inner frame dimension - do not measure the existing door. Corinthian and Minster doors under 2080mm wide have three panels, not four (see Doric and Victoria). The tables detail the pricing structure for made to measure garage doors. Any size of garage door falling within each band is priced at the upper limit of the band. e.g. for an unframed, tracked Corinthian garage door measuring 7'2" wide x 6'9" high (2184mm x 2057mm) use width band 7'6" (2286mm) and height band 7'0" (2134mm) = **Price £1002**

### OPTIONS AVAILABLE - PAINTED STEEL DOORS

#### W FULLY FINISHED DEEP TEXTURED WHITE

- For single doors Add **£59**
- For double doors Add **£90**

Note: This door finish does NOT require overpainting.

#### F FRAMED DOORS

- For single doors Add **£95**
- For double doors Add **£170**

Choose either: Standard width frame (68mm jamb) or Narrow width frame (canopy gear only, 54mm jamb)

Frames supplied to match the door finish. Doors can be supplied with a white finished frame on request.

#### C FULLY FINISHED DEEP TEXTURED COLOURS

- For single doors Add **£85**
- For double doors Add **£133**

Colours available: Monarch Red - Balmoral Green - Conker Brown - Ebony Black - Oxford Blue - Metallic Grey - Mushroom Grey - White. These doors do NOT require overpainting

Note: All doors painted inside and out to chosen colour.

#### 4 FOUR POINT LOCKING

To convert existing 2 point locking system to 4 point locking (Kit supplied)

- For single doors Add **£26**
- For double doors Add **£41**



#### V VISION WINDOWS

- For single doors Add **£114**
- For double doors Add **£191**

# PREMIERE PLASTISOL & LAMINATE STEEL DOORS

## STANDARD SINGLE AND DOUBLE SIZES

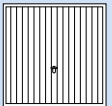
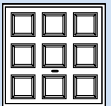
### OPTIONS

			
MERLIN	REGENT	DORIC II	LUMLEY
<b>S 4 F</b>	<b>S 4 F</b>	<b>S 4 F</b>	<b>S 4 F</b>

WIDTH METRIC x HEIGHT IMPERIAL	CANOPY		TRACKED		CANOPY		TRACKED		CANOPY		TRACKED	
	1930 x 2134	488	528	558	598	691	731	558	598	691	731	558
1981 x 1981	482	522	543	583	691	731	543	583	691	731	543	583
1981 x 2134	497	537	544	584	710	750	544	584	710	750	544	584
2083 x 1905	512	-	573	-	-	-	573	-	-	-	573	-
2083 x 1930	512	552	573	613	681	721	573	613	681	721	573	613
2083 x 1956	512	552	573	613	681	721	573	613	681	721	573	613
2083 x 1981	520	560	573	613	681	721	573	613	681	721	573	613
2083 x 2057	530	570	584	624	692	732	584	624	692	732	584	624
2083 x 2134	532	572	586	626	698	738	586	626	698	738	586	626
2108 x 1981	530	570	584	624	692	732	584	624	692	732	584	624
2108 x 2057	532	572	586	626	698	738	586	626	698	738	586	626
2108 x 2134	534	574	590	630	701	741	590	630	701	741	590	630
2134 x 1829	502	-	565	-	-	-	565	-	-	-	565	-
2134 x 1880	504	-	564	-	-	-	564	-	-	-	564	-
2134 x 1905	506	-	566	-	-	-	566	-	-	-	566	-
2134 x 1930	506	546	566	606	666	706	566	606	666	706	566	606
2134 x 1956	506	546	566	606	666	706	566	606	666	706	566	606
2134 x 1981	457	497	542	582	653	693	542	582	653	693	542	582
2134 x 2057	520	560	565	605	691	731	565	605	691	731	565	605
2134 x 2134	514	554	560	600	687	727	560	600	687	727	560	600
2210 x 1930	530	570	599	639	751	791	599	639	751	791	599	639
2210 x 1981	544	584	609	649	762	802	609	649	762	802	609	649
2210 x 2134	544	584	609	649	762	802	609	649	762	802	609	649
2261 x 1981	544	584	609	649	762	802	609	649	762	802	609	649
2261 x 2134	610	650	667	707	889	929	667	707	889	929	667	707
2286 x 1829	532	-	575	-	-	-	575	-	-	-	575	-
2286 x 1880	547	-	600	-	-	-	600	-	-	-	600	-
2286 x 1905	533	-	583	-	-	-	583	-	-	-	583	-
2286 x 1930	533	573	584	624	734	774	584	624	734	774	584	624
2286 x 1981	531	571	584	624	734	774	584	624	734	774	584	624
2286 x 2134	599	639	648	688	861	901	648	688	861	901	648	688
2438 x 1905	585	-	666	-	-	-	666	-	-	-	666	-
2438 x 1930	604	644	680	720	896	936	680	720	896	936	680	720
2438 x 1981	604	644	680	720	896	936	680	720	896	936	680	720
2438 x 2134	617	657	769	809	933	973	769	809	933	973	769	809

Door prices shown are for White Plastisol finish.

### OPTIONS

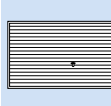
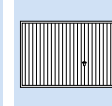
	
MERLIN	REGENT
<b>S 4 F</b>	<b>S 4 F</b>

WIDTH METRIC x HEIGHT IMPERIAL	CANOPY		TRACKED		CANOPY		TRACKED	
	2591 x 1981 / 2134	8'6" x 6'6"/7'	-	733	-	953	-	953
2743 x 1981 / 2134	9' x 6'6"/7'	-	940	-	1024	-	1024	
3048 x 1981 / 2134	10' x 6'6"/7'	-	1309	-	1378	-	1378	
3353 x 1981 / 2134	11' x 6'6"/7'	-	1401	-	1464	-	1464	
3658 x 1981 / 2134	12' x 6'6"/7'	-	1480	-	1547	-	1547	
3962 x 1981 / 2134	13' x 6'6"/7'	-	1537	-	1614	-	1614	
4242 x 1981 / 2134	13'11" x 6'6"/7'	-	1546	-	1617	-	1617	
4267 x 1981 / 2134	14' x 6'6"/7'	-	1488	-	1488	-	1488	
4420 x 1981 / 2134	14'6" x 6'6"/7'	-	1674	-	1654	-	1654	
4572 x 1981 / 2134	15' x 6'6"/7'	-	-	-	1693	-	1693	
4877 x 1981 / 2134	16' x 6'6"/7'	-	-	-	1879	-	1879	

Door prices shown are for White Plastisol finish.

### OPTIONS

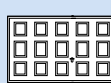
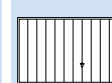
	
DORIC II	LUMLEY
<b>S 4 F</b>	<b>S 4 F</b>

WIDTH METRIC x HEIGHT IMPERIAL	CANOPY		TRACKED		CANOPY		TRACKED	
	2591 x 1981 / 2134	8'6" x 6'6"/7'	-	1119	-	953	-	953
2743 x 1981 / 2134	9' x 6'6"/7'	-	1260	-	1099	-	1099	
3048 x 1981 / 2134	10' x 6'6"/7'	-	1480	-	1378	-	1378	
3353 x 1981 / 2134	11' x 6'6"/7'	-	1566	-	1385	-	1385	
3658 x 1981 / 2134	12' x 6'6"/7'	-	1713	-	1547	-	1547	
3962 x 1981 / 2134	13' x 6'6"/7'	-	1870	-	1614	-	1614	
4242 x 1981 / 2134	13'11" x 6'6"/7'	-	1882	-	1617	-	1617	
4267 x 1981 / 2134	14' x 6'6"/7'	-	1834	-	1488	-	1488	
4420 x 1981 / 2134	14'6" x 6'6"/7'	-	1958	-	-	-	-	
4572 x 1981 / 2134	15' x 6'6"/7'	-	2081	-	-	-	-	
4877 x 1981 / 2134	16' x 6'6"/7'	-	2204	-	-	-	-	

Door prices shown are for White Plastisol finish.

#### **S** LAMINATE WOOD -EFFECT STEEL FINISH

- For single doors Add **£60**
- For double doors Add **£110**

Colours available: Golden Oak and Rosewood

#### **F** FRAMED DOORS

- For single doors Add **£95**
- For double doors Add **£170**

Choose either:

Choose either:

Standard width frame (60mm jamb) or Narrow width frame (canopy gear only, 54mm jamb)

Frames supplied to match the door finish. Doors can be supplied with a white finished frame on request.



#### **4** FOUR POINT LOCKING

To convert existing 2 point locking system to 4 point locking (Kit supplied)

- For single doors Add **£26**
- For double doors Add **£41**

# PREMIERE PLASTISOL & LAMINATE STEEL DOORS

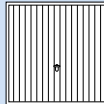
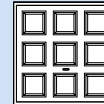
MADE TO MEASURE SIZES

									
		<b>MERLIN</b>		<b>REGENT</b>		<b>DORIC II</b>		<b>LUMLEY</b>	
		Min. size (w x h): 1829 x 1829mm (6'0" x 6'0")		Min. size (w x h): 1829 x 1829mm (6'0" x 6'0")		Min. size (w x h): 1930 x 1930mm (6'4" x 6'4")		Min. size (w x h): 1930 x 1905mm (6'4" x 6'3")	
		<b>S 4 F</b>		<b>S 4 F</b>		<b>S 4 F</b>		<b>S 4 F</b>	
		CANOPY		CANOPY		CANOPY		CANOPY	
		TRACKED		TRACKED		TRACKED		TRACKED	
WIDTH x HEIGHT									
METRIC									
IMPERIAL									
1981 x 1981 / 2134	6'6" x 6'6" / 7'0"	662	702	786	826	951	991	786	826
2134 x 1981 / 2134	7' x 6'6" / 7'0"	662	702	786	826	951	991	786	826
2286 x 1981 / 2134	7'6" x 6'6" / 7'0"	706	746	827	867	1027	1067	827	867
2438 x 1981 / 2134	8' x 6'6" / 7'0"	786	826	916	956	1220	1260	916	956
2591 x 1981 / 2134	8'6" x 6'6" / 7'0"	-	1010	-	1113	-	1491	-	1113
2743 x 1981 / 2134	9' x 6'6" / 7'0"	-	1147	-	1232	-	1685	-	1222
3048 x 1981 / 2134	10' x 6'6" / 7'0"	-	1443	-	1487	-	2000	-	1487
3353 x 1981 / 2134	11' x 6'6" / 7'0"	-	1513	-	1572	-	2095	-	1572
3658 x 1981 / 2134	12' x 6'6" / 7'0"	-	1600	-	1660	-	2192	-	1660
3962 x 1981 / 2134	13' x 6'6" / 7'0"	-	1689	-	1753	-	2344	-	1753
4267 x 1981 / 2134	14' x 6'6" / 7'0"	-	1782	-	1857	-	2408	-	1857
4572 x 1981 / 2134	15' x 6'6" / 7'0"	-	-	-	1953	-	2520	-	-
4877 x 1981 / 2134	16' x 6'6" / 7'0"	-	-	-	2066	-	2640	-	-
1981 x 2286	6'6" x 7'6"	-	741	-	866	-	-	-	-
2134 x 2286	7' x 7'6"	-	773	-	893	-	-	-	-
2286 x 2286	7'6" x 7'6"	-	849	-	964	-	-	-	-
2438 x 2286	8' x 7'6"	-	885	-	1047	-	-	-	-
2591 x 2286	8'6" x 7'6"	-	1080	-	1206	-	-	-	-
2743 x 2286	9' x 7'6"	-	1222	-	1310	-	-	-	-
3048 x 2286	10' x 7'6"	-	1547	-	1605	-	-	-	-
3353 x 2286	11' x 7'6"	-	1627	-	1690	-	-	-	-
3658 x 2286	12' x 7'6"	-	1719	-	1788	-	-	-	-
3962 x 2286	13' x 7'6"	-	1817	-	1884	-	-	-	-
4267 x 2286	14' x 7'6"	-	1924	-	1996	-	-	-	-
4572 x 2286	15' x 7'6"	-	-	-	2104	-	-	-	-
4877 x 2286	16' x 7'6"	-	-	-	2221	-	-	-	-

Door prices shown are for White Plastisol finish.

## MADE TO MEASURE PRICING

**Sizing:** Sizes shown for garage doors refer to inner frame dimensions. To measure for a garage door, use the inner frame dimension - do not measure the existing door. Corinthian and Minster doors under 2080mm wide have three panels, not four (see Doric II). The tables detail the pricing structure for made to measure garage doors. Any size of garage door falling within each band is priced at the upper limit of the band. e.g. for an unframed, tracked Doric II garage door measuring 7'2" wide x 6'9" high (2184mm x 2057mm) using width band 7'6" (2286mm) and height band 7'0" (2134mm) = **Price £1067**

### OPTIONS AVAILABLE - PLASTISOL AND LAMINATE STEEL DOORS

#### **S** LAMINATE WOOD -EFFECT STEEL FINISH

- For single doors Add **£60**
- For double doors Add **£110**

Colours available: Golden Oak and Rosewood

#### **F** FRAMED DOORS

- For single doors Add **£95**
- For double doors Add **£170**

Choose either:

Standard width frame (68mm jamb) or Narrow width frame (canopy gear only, 54mm jamb)

Frames supplied to match the door finish. Doors can be supplied with a white finished frame on request.

#### **4** FOUR POINT LOCKING

To convert existing 2 point locking system to 4 point locking (Kit supplied)

- For single doors Add **£26**
- For double doors Add **£41**

# ABS DOORS

Doors are available in standard and made to measure sizes as shown in the tables on the facing page. For made to measure doors please check the sizing information shown below to confirm your required size is available for your chosen style.

#### BEDFORD

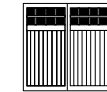

	Minimum	Maximum	Minimum	Maximum
Width	6' 8"	8' 4"	-	-
Height	2032	2540	-	-
	1873	2216	-	-

#### JACOBAN

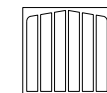

	Minimum	Maximum	Minimum	Maximum
Width	6' 6 <sup>3</sup> / <sub>8</sub> "	8' 3 <sup>3</sup> / <sub>8</sub> "	-	-
Height	1991	2524	-	-
	1895	2223	-	-

#### PRESIDENT



	Minimum	Maximum	Minimum	Maximum
Width	6' 5 <sup>3</sup> / <sub>8</sub> "	8' 4"	12' 11 <sup>3</sup> / <sub>4</sub> "	14' 9 <sup>3</sup> / <sub>4</sub> "
Height	1959	2540	3956	4515
	1930	2229	1930	2229

#### REGAL

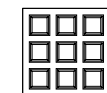

	3 panel		4 panel	
	Minimum	Maximum	Minimum	Maximum
Width	6' 3 <sup>3</sup> / <sub>4</sub> "	8' 4 <sup>3</sup> / <sub>4</sub> "	8' 5"	9' 17 <sup>8</sup> / <sub>8</sub> "
Height	1911	2559	2565	2791
	1918	2235	1918	2235
	3 panel		4 panel	
	Minimum	Maximum	Minimum	Maximum
Width	10' 6 <sup>7</sup> / <sub>8</sub> "	11' 3 <sup>3</sup> / <sub>4</sub> "	12' 8 <sup>7</sup> / <sub>8</sub> "	14' 9"
Height	3223	3448	3883	4515
	1918	2235	1918	2235

#### SENATOR

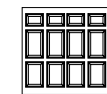

	4 panel		5 panel	
	Minimum	Maximum	Minimum	Maximum
Width	6' 7 <sup>3</sup> / <sub>8</sub> "	8' 4 <sup>1</sup> / <sub>2</sub> "	8' 3 <sup>3</sup> / <sub>8</sub> "	8' 8 <sup>1</sup> / <sub>8</sub> "
Height	2016	2552	2524	2645
	1829	2235	1829	2235
	6 panel		7 panel	
	Minimum	Maximum	Minimum	Maximum
Width	9' 11 <sup>3</sup> / <sub>8</sub> "	10' 4 <sup>1</sup> / <sub>4</sub> "	11' 7 <sup>3</sup> / <sub>8</sub> "	12' 0 <sup>1</sup> / <sub>4</sub> "
Height	3032	3156	3540	3664
	1829	2235	1829	2235

#### 8 panel

	Minimum	Maximum		
Width	13' 3 <sup>3</sup> / <sub>8</sub> "	14' 9 <sup>3</sup> / <sub>4</sub> "		
Height	4048	4515		
	1829	2235		

#### TUDOR

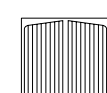

	Minimum	Maximum	Minimum	Maximum
Width	6' 6 <sup>3</sup> / <sub>8</sub> "	8' 3 <sup>5</sup> / <sub>8</sub> "	-	-
Height	1991	2530	-	-
	1905	2210	-	-

# ABS DOORS

## STANDARD SINGLE SIZES

OPTIONS	JACOBAN		REGAL		SENATOR		BEDFORD		PRESIDENT		TUDOR	
	F H 4		F V H 4		F V H 4		F V H 4		F H 4		F H 4	
WIDTH x HEIGHT METRIC IMPERIAL	CANOPY	TRACKED	CANOPY	TRACKED	CANOPY	TRACKED	CANOPY	TRACKED	CANOPY	TRACKED	CANOPY	TRACKED
2134 x 1981 7'0" x 6'6"	845	885	804	844	845	885	928	968	928	968	845	885
2134 x 2134 7'0" x 7'0"	845	885	804	844	845	885	928	968	928	968	845	885
2286 x 1981 7'6" x 6'6"	928	968	889	929	928	968	1013	1053	1013	1053	928	968
2286 x 2134 7'6" x 7'0"	928	968	889	929	928	968	1013	1053	1013	1053	928	968
2438 x 1981 8'0" x 6'6"	1013	1053	974	1014	1013	1053	1096	1136	1096	1136	1013	1053
2438 x 2134 8'0" x 7'0"	1013	1053	974	1014	1013	1053	1096	1136	1096	1136	1013	1053

## STANDARD DOUBLE SIZES

WIDTH x HEIGHT METRIC IMPERIAL	RETRACTABLE	RETRACTABLE	RETRACTABLE	RETRACTABLE	RETRACTABLE	RETRACTABLE
4267 x 1981 14'0" x 6'6"	1966	1883	1966	-	2090	-
4267 x 2134 14'0" x 7'0"	1966	1883	1966	-	2090	-

## MADE TO MEASURE SINGLE DOORS - Sizes up to:

WIDTH x HEIGHT METRIC IMPERIAL	CANOPY	TRACKED	CANOPY	TRACKED	CANOPY	TRACKED	CANOPY	TRACKED	CANOPY	TRACKED	CANOPY	TRACKED
2134 x 2134 7'0" x 7'0"	971	1011	928	968	971	1011	1052	1092	1052	1092	971	1011
2286 x 2134 7'6" x 7'0"	1052	1092	1013	1053	1052	1092	1136	1176	1136	1176	1052	1092
2438 x 2134 8'0" x 7'0"	1136	1176	1096	1136	1136	1176	1221	1261	1221	1261	1136	1176

## MADE TO MEASURE DOUBLE DOORS - Sizes up to:

WIDTH x HEIGHT METRIC IMPERIAL	RETRACTABLE	RETRACTABLE	RETRACTABLE	RETRACTABLE	RETRACTABLE	RETRACTABLE
2591 x 2134 8'6" x 7'0"	1292	1250	1292	1439	1439	1439
2743 x 2134 9'0" x 7'0"	-	1250	1292	-	-	-
3048 x 2134 10'0" x 7'0"	-	1412	1460	-	-	-
3353 x 2134 11'0" x 7'0"	-	1569	1649	-	-	-
3658 x 2134 12'0" x 7'0"	-	1661	1809	-	2090	-
3962 x 2134 13'0" x 7'0"	-	1729	-	-	2238	-
4267 x 2134 14'0" x 7'0"	-	2039	2095	-	2285	-
4572 x 2134 15'0" x 7'0"	-	2357	2437	-	2469	-

**Sizing:** Sizes shown for garage doors refer to inner frame dimensions. To measure for a garage door, use the inner frame dimension - do not measure the existing door. President doors under 2080mm wide have three panels, not four (see Regal). The tables detail the pricing structure for made to measure garage doors. Any size of garage door falling within each band is priced at the upper limit of the band. e.g. for an unframed, tracked President garage door measuring 7'2" wide x 6'9" high (2184mm x 2057mm) use width band 7'6" (2286mm) and height band 7'0" (2134mm) = **Price £1176**

### OPTIONS AVAILABLE - ABS GARAGE DOORS

#### F FRAMED DOORS

From Jan 4th frames supplied in White, Black or Brown powder coat painted finish.

- For single doors Add **£95**
- For double doors Add **£170**

Standard width frame (68mm jamb) or Narrow width frame (canopy gear only, 54mm jamb)

Until Jan 4th frames supplied in primed finish.

- For single doors 54/68mm Add **£95/£110**
- For double doors Add **£190**

Until Jan 4th frames supplied in White Plastisol finish only.

- For single doors 54/68mm Add **£110/£125**
- For double doors Add **£205**

#### 4 FOUR POINT LOCKING

Available from January.

To convert existing 2 point locking system to 4 point locking (Kit supplied)

- For single doors Add **£26**
- For double doors Add **£41**

#### H HANDLE OPTIONS

- Brass effect Add **£42**

Available until Jan 4th.

#### V VISION WINDOWS

Stippled Plain, Square Lattice, Diamond Lattice & Queen Anne Lattice

- For single doors Add **£220**
- For double doors Add **£410**

Stippled Plain for Bedford only.

- For single doors Add **£100**
- For double doors Add **£195**

# TIMBER DOORS

## STANDARD SINGLE SIZES

DOOR CONSTRUCTION			MONARCH		BERGEN		BERGEN CHEVRON		WARWICK		LINCOLN		GLOUCESTER	
OPTIONS			F 4 W		F 4 W		F 4 W		F 4 W		F 4 W		F 4 W	
ORDER NUMBER	WIDTH METRIC	HEIGHT IMPERIAL	CANOPY	TRACKED	CANOPY	TRACKED	CANOPY	TRACKED	CANOPY	TRACKED	CANOPY	TRACKED	CANOPY	TRACKED
7066	2134 x 1981	7'0" x 6'6"	909	949	1140	1180	1491	1531	1115	1155	1115	1155	1115	1155
7070	2134 x 2134	7'0" x 7'0"	940	980	1206	1246	1526	1566	1158	1198	1158	1198	1158	1198
7666	2286 x 1981	7'6" x 6'6"	-	1041	-	1271	-	1613	-	1269	-	1269	-	1269
7670	2286 x 2134	7'6" x 7'0"	-	1086	-	1293	-	1641	-	1306	-	1306	-	1306
7676	2286 x 2286	7'6" x 7'6"	-	1115	-	1323	-	1699	-	1331	-	1331	-	1331
8066	2438 x 1981	8'0" x 6'6"	-	1138	-	1370	-	1808	-	1403	-	1403	-	1403
8070	2438 x 2134	8'0" x 7'0"	-	1187	-	1459	-	1894	-	1455	-	1455	-	1455
8076	2438 x 2286	8'0" x 7'6"	-	1254	-	1582	-	1950	-	1532	-	1532	-	1532

## STANDARD SINGLE SIZES

DOOR CONSTRUCTION			BUCKINGHAM		BRANDON		BEVERSTONE		BALMORAL		BERKELEY		BERGEN DIAGONAL	
OPTIONS			F 4 W		F 4 W		F 4 W		F 4 W		F 4 W		F 4 W	
ORDER NUMBER	WIDTH METRIC	HEIGHT IMPERIAL	CANOPY	TRACKED	CANOPY	TRACKED	CANOPY	TRACKED	CANOPY	TRACKED	CANOPY	TRACKED	CANOPY	TRACKED
7066	2134 x 1981	7'0" x 6'6"	1236	1276	1115	1155	1491	1531	1115	1155	1258	1298	1342	1382
7070	2134 x 2134	7'0" x 7'0"	1285	1325	1158	1198	1526	1566	1158	1198	1287	1327	1374	1414
7666	2286 x 1981	7'6" x 6'6"	-	1414	-	1269	-	1613	-	1269	-	1445	-	1452
7670	2286 x 2134	7'6" x 7'0"	-	1451	-	1306	-	1641	-	1306	-	1493	-	1477
7676	2286 x 2286	7'6" x 7'6"	-	1532	-	1331	-	1699	-	1331	-	1532	-	1529
8066	2438 x 1981	8'0" x 6'6"	-	1559	-	1403	-	1808	-	1403	-	1584	-	1532
8070	2438 x 2134	8'0" x 7'0"	-	1614	-	1455	-	1894	-	1455	-	1640	-	1704
8076	2438 x 2134	8'0" x 7'6"	-	1672	-	1532	-	1950	-	1532	-	1672	-	1755

All doors are supplied base coat stained for finishing to the colour of your choice or select from one of the factory applied finish options available. The Berkeley is supplied with stippled, diamond lattice or square lattice window as a no cost option.

### OPTIONS AVAILABLE - TIMBER DOORS

#### F FRAMED DOORS

- For single doors Add **£95**  
Choose either: Standard width frame (68mm jamb) or Narrow width frame (canopy gear only, 54mm jamb).
- For double doors Add **£170**  
Standard width frame (68mm jamb).

#### W WOODSTAIN FINISH

- For single doors Add **£118**
  - For double doors Add **£195**
- Colours available: Dark Oak - Light Oak - Burnt Oak - Mahogany - Walnut

#### 4 FOUR POINT LOCKING

- To convert existing 2 point locking system to 4 point locking (Kit supplied)
- For single doors Add **£26**
  - For double doors Add **£41**

Note: Frames supplied in fully finished Conker Brown. Doors can be supplied with a white finished frame on request.

Note: Factory applied timber finishes produce a raised grain effect on the door panel in the same way as on-site door finishing.

# TIMBER DOORS

## STANDARD DOUBLE SIZES

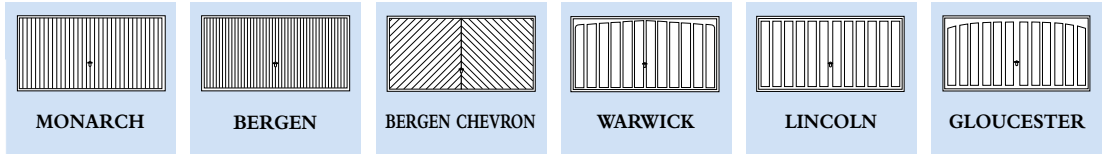

ORDER NUMBER	WIDTH METRIC	HEIGHT IMPERIAL	MONARCH		BERGEN		BERGEN CHEVRON		WARWICK		LINCOLN		GLOUCESTER	
			CANOPY	TRACKED	CANOPY	TRACKED	CANOPY	TRACKED	CANOPY	TRACKED	CANOPY	TRACKED	CANOPY	TRACKED
1466	4267 x 1981	14'0" x 6'6"	-	2333	-	2669	-	3381	-	2484	-	2484	-	2484
1470	4267 x 2134	14'0" x 7'0"	-	2333	-	2669	-	3381	-	2484	-	2484	-	2484

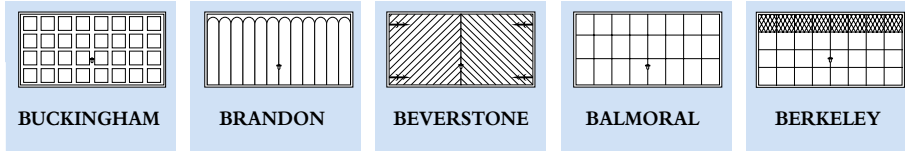

ORDER NUMBER	WIDTH METRIC	HEIGHT IMPERIAL	BUCKINGHAM		BRANDON		BEVERSTONE		BALMORAL		BERKELEY	
			CANOPY	TRACKED	CANOPY	TRACKED	CANOPY	TRACKED	CANOPY	TRACKED	CANOPY	TRACKED
1466	4267 x 1981	14'0" x 6'6"	-	2756	-	2484	-	3381	-	2484	-	2847
1470	4267 x 2134	14'0" x 7'0"	-	2756	-	2484	-	3381	-	2484	-	2847

The Berkeley is supplied with stippled, diamond lattice or square lattice window as a no cost option.

## LIFTING GEAR FOR USE WITH HANDMADE TIMBER DOORS

### DOOR BRACE AND LOCK PACKS

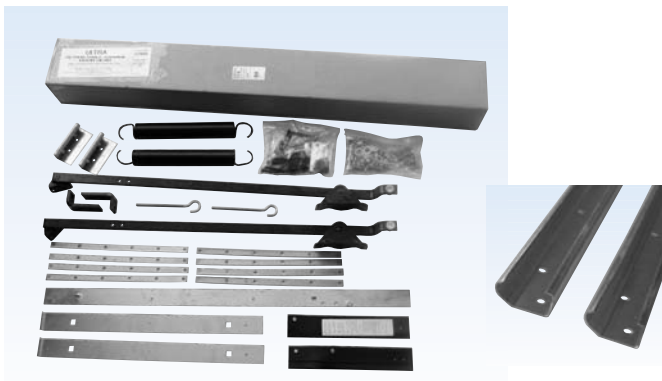

Lifting gear for use with your own created timber garage door. Add Ultra gear to your timber panel to create an up and over garage door. The kit has side springs and horizontal tracks to carry the door into the garage. The set number denotes the maximum door weight in lbs the kit is suitable for. For example, a U150 kit can be used with a door panel weighing up to 150lbs. Door braces and locks are ordered separately.

Set No.	Door height minimum - maximum	Price
U100 (short)	1880 (6'2") 1981 (6'6")	£173.25
U100	1981 (6'6") 2134 (7'0")	£173.25
U150	1981 (6'6") 2134 (7'0")	£207.90
U200	1981 (6'6") 2134 (7'0")	£270.27
U250	2057 (6'9") 2286 (7'6")	£337.84

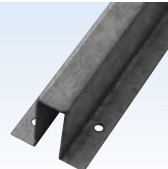

Part No: 034313  
**Door brace U150/200** £9.53  
 (Single length 5'6")

Part No: 034337  
**Door brace DB250** £12.72  
 (Single length 7'6". Recommended to order in pairs)



Part No: 033974  
**Lock arm** £4.77  
 5'0<sup>3</sup>/<sub>4</sub>" long

Part No: 033998  
**Lock arm** £10.32  
 8'0<sup>1</sup>/<sub>2</sub>" long



Part No: 086158  
**ELB Lock pack complete** £38.13

Lock pack complete with fixings for use with Ultra lifting gear. This is for use with your own manufactured doors fitted with Henderson Ultra lifting gear

# GRP DOORS

## STANDARD SINGLE & DOUBLE & MADE TO MEASURE SIZES

### STANDARD SINGLE SIZES

#### STANDARD FINISHES

#### OPTIONS

CAVERSHAM		ASHTON		CONSORT		ABBEY		CUMBERLAND		PRESIDENT		SOLSTICE		
Woodgrain White, Magnolia, Light Oak, Honey Beech, Dark Oak, Bronze Sheen, Dark Mahogany, Rosewood, Bleached Oak		Woodgrain White, Magnolia, Light Oak, Honey Beech, Dark Oak, Bronze Sheen, Dark Mahogany, Rosewood, Bleached Oak		Smooth Gloss White		Woodgrain White, Magnolia, Light Oak, Honey Beech, Dark Oak, Bronze Sheen, Dark Mahogany, Rosewood, Bleached Oak		Woodgrain White, Magnolia, Light Oak, Honey Beech, Dark Oak, Bronze Sheen, Dark Mahogany, Rosewood, Bleached Oak		Smooth Gloss White		Smooth Gloss White with Black mock glazing		
<b>F V H 4</b>		<b>F 4 H</b>		<b>F V H 4</b>		<b>F 4 H</b>		<b>F 4 H</b>		<b>F 4 H</b>		<b>F V H 4</b>		
ORDER NUMBER	WIDTH x HEIGHT METRIC	HEIGHT IMPERIAL	CANOPY	TRACKED	CANOPY	TRACKED	CANOPY	TRACKED	CANOPY	TRACKED	CANOPY	TRACKED	CANOPY	TRACKED
7066	2134 x 1981	7'0" x 6'6"	1314	1354	1336	1376	1027	1067	1208	1248	1285	1325	1228	1268
7070	2134 x 2134	7'0" x 7'0"	1314	1354	1336	1376	1027	1067	1208	1248	1285	1325	1228	1268

### STANDARD DOUBLE SIZES

CAVERSHAM		ASHTON		CONSORT		ABBEY		CUMBERLAND		PRESIDENT		SOLSTICE		
ORDER NUMBER	WIDTH x HEIGHT METRIC	HEIGHT IMPERIAL	CANOPY	TRACKED	CANOPY	TRACKED	CANOPY	TRACKED	CANOPY	TRACKED	CANOPY	TRACKED	CANOPY	TRACKED
1466	4267 x 1981	14'0" x 6'6"	-	2393	-	2477	-	2071	-	2464	-	2408	-	2375
1470	4267 x 2134	14'0" x 7'0"	-	2393	-	2477	-	2071	-	2464	-	2408	-	2375

### MADE TO MEASURE SIZES

#### Minimum Garage Door Sizes (w x h)

CAVERSHAM		ASHTON		CONSORT		ABBEY		CUMBERLAND		PRESIDENT		SOLSTICE	
Min size (w x h): 2134 x 1981 (7'0" x 6'6")		Min size (w x h): 2134 x 1981 (7'0" x 6'6")		Min size (w x h): 2134 x 1981 (7'0" x 6'6")		Min size (w x h): 2134 x 1981 (7'0" x 6'6")		Min size (w x h): 2134 x 1981 (7'0" x 6'6")		Min size (w x h): 2134 x 1981 (7'0" x 6'6")		Min size (w x h): 2134 x 1981 (7'0" x 6'6")	
WIDTH x HEIGHT METRIC	HEIGHT IMPERIAL	CANOPY	TRACKED	CANOPY	TRACKED	CANOPY	TRACKED	CANOPY	TRACKED	CANOPY	TRACKED	CANOPY	TRACKED
2134 x 1981	7'0" x 6'6"	-	-	-	-	-	-	-	-	-	-	-	-
2286 x 1981	7'6" x 6'6"	1564	1604	1546	1586	1280	1320	1458	1498	1499	1539	1481	1521
2438 x 1981	8'0" x 6'6"	1564	1604	1546	1586	1280	1320	1458	1498	1499	1539	1481	1521
2591 x 1981	8'6" x 6'6"	1641	1681	-	-	1412	1452	1564	1604	1603	1643	-	-
2743 x 1981	9'0" x 6'6"	-	1769	-	-	-	1457	-	1609	-	1648	-	-
2895 x 1981	9'6" x 6'6"	-	1856	-	-	-	1590	-	1767	-	1838	-	-
3048 x 1981	10'0" x 6'6"	-	1856	-	-	-	1590	-	1767	-	1838	-	-
3353 x 1981	11'0" x 6'6"	-	2057	-	-	-	1711	-	1938	-	2037	-	-
3658 x 1981	12'0" x 6'6"	-	2242	-	-	-	1855	-	2133	-	2242	-	-
3962 x 1981	13'0" x 6'6"	-	2404	-	-	-	2026	-	2351	-	2368	-	-
4267 x 1981	14'0" x 6'6"	-	2511	-	-	-	2026	-	2586	-	2527	-	-
4572 x 1981	15'0" x 6'6"	-	2641	-	2888	-	2291	-	2845	-	2779	-	-

### MADE TO MEASURE PRICING

**Sizing:** Sizes shown for garage doors refer to inner frame dimensions. To measure for a garage door, use the inner frame dimension - do not measure the existing door. The tables detail the pricing structure for made to measure garage doors. Any size of garage door falling within each band is priced at the upper limit of the band. e.g. For an unframed, tracked Caversham garage door measuring 7'2" wide x 6'9" high (2184mm x 2057mm) use width band 7'6" (2286mm) and height band 7'0" (2134mm) = **Price £1604**

### OPTIONS AVAILABLE - GRP GARAGE DOORS

#### F FRAMED DOORS

From Feb 1st frames supplied in White, Black or Brown powder coat painted finish.

- For single doors Add **£95**
- For double doors Add **£170**

Choose either: Standard width frame (68mm jamb) or Narrow width frame (canopy gear only, 54mm jamb)

Until Feb 1st frames supplied in primed finish.

- For single doors 54/68mm Add **£95/£110**
- For double doors Add **£190**

Until Feb 1st frames supplied in White, Black or Brown Plastisol finish.

- For single doors 54/68mm Add **£110/£125**
- For double doors Add **£205**

Until Feb 1st frames supplied in a Golden Oak and Rosewood woodgrain finish.

- For single doors 54/68mm Add **£120/£135**
- For double doors Add **£215**

Although sharing the same name, Rosewood Glasswood GRP doors and Rosewood Weathergrain steel frames are not a match for colour. Dark Mahogany is the closest in colour - always ask to see a sample if you are unsure.

**Note: Single doors are sizes up to and including 8ft (2438mm) wide. Doors over this size are classed as double doors.**

# GRP DOORS

MADE TO MEASURE SIZES

Minimum Garage Door Sizes (w x h)

**STANDARD FINISHES**

**OPTIONS**

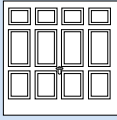
	CAVERSHAM		ASHTON		CONSORT		ABBEY		CUMBERLAND		PRESIDENT		SOLSTICE		
	<b>CAVERSHAM</b>		<b>ASHTON</b>		<b>CONSORT</b>		<b>ABBEY</b>		<b>CUMBERLAND</b>		<b>PRESIDENT</b>		<b>SOLSTICE</b>		
Min size (w x h): 2134 x 1981 (7'0" x 6'6")	Min size (w x h): 2134 x 1981 (7'0" x 6'6")		Min size (w x h): 2134 x 1981 (7'0" x 6'6")		Min size (w x h): 2134 x 1981 (7'0" x 6'6")		Min size (w x h): 2134 x 1981 (7'0" x 6'6")		Min size (w x h): 2134 x 1981 (7'0" x 6'6")		Min size (w x h): 2134 x 1981 (7'0" x 6'6")		Min size (w x h): 2134 x 1981 (7'0" x 6'6")		
Woodgrain White, Magnolia, Light Oak, Honey Beech, Dark Oak, Bronze Sheen, Dark Mahogany, Rosewood, Bleached Oak	Woodgrain White, Magnolia, Light Oak, Honey Beech, Dark Oak, Bronze Sheen, Dark Mahogany, Rosewood, Bleached Oak		Woodgrain White, Magnolia, Light Oak, Honey Beech, Dark Oak, Bronze Sheen, Dark Mahogany, Rosewood, Bleached Oak		Smooth Gloss White		Woodgrain White, Magnolia, Light Oak, Honey Beech, Dark Oak, Bronze Sheen, Dark Mahogany, Rosewood, Bleached Oak		Woodgrain White, Magnolia, Light Oak, Honey Beech, Dark Oak, Bronze Sheen, Dark Mahogany, Rosewood, Bleached Oak		Smooth Gloss White		Smooth Gloss White with Black mock glazing		
<b>F V H</b> <b>4</b>	<b>F V H</b> <b>4</b>		<b>F V H</b> <b>4</b>		<b>F V H</b> <b>4</b>		<b>F H 4</b>		<b>F H 4</b>		<b>F H 4</b>		<b>F V H</b> <b>4</b>		
WIDTH x HEIGHT METRIC IMPERIAL	CANOPY	TRACKED	CANOPY	TRACKED	CANOPY	TRACKED	CANOPY	TRACKED	CANOPY	TRACKED	CANOPY	TRACKED	CANOPY	TRACKED	
2134 x 2134	7'0" x 7'0"	1564	1604	1404	1444	1082	1122	1266	1306	1352	1392	1380	1420	1193	1233
2286 x 2134	7'6" x 7'0"	1564	1604	1546	1586	1280	1320	1458	1498	1499	1539	1481	1521	1412	1452
2438 x 2134	8'0" x 7'0"	1564	1604	1546	1586	1280	1320	1458	1498	1499	1539	1481	1521	1412	1452
2591 x 2134	8'6" x 7'0"	-	1769	-	-	-	1457	-	1609	-	1648	-	-	-	-
2743 x 2134	9'0" x 7'0"	-	1769	-	-	-	1457	-	1609	-	1648	-	-	-	-
2895 x 2134	9'6" x 7'0"	-	1856	-	-	-	1590	-	1767	-	1838	-	-	-	-
3048 x 2134	10'0" x 7'0"	-	1856	-	-	-	1590	-	1767	-	1838	-	-	-	-
3353 x 2134	11'0" x 7'0"	-	2057	-	-	-	1711	-	1938	-	2037	-	-	-	-
3658 x 2134	12'0" x 7'0"	-	2242	-	-	-	1855	-	2133	-	2242	-	-	-	-
3962 x 2134	13'0" x 7'0"	-	2404	-	-	-	2026	-	2351	-	2368	-	-	-	-
4267 x 2134	14'0" x 7'0"	-	2511	-	-	-	2173	-	2586	-	2530	-	-	-	-
4572 x 2134	15'0" x 7'0"	-	2641	-	2888	-	2291	-	2845	-	2779	-	-	-	-

Minimum Garage Door Sizes (w x h)

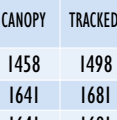
	CAVERSHAM		ASHTON		CONSORT		ABBEY		CUMBERLAND		PRESIDENT		SOLSTICE		
	<b>CAVERSHAM</b>		<b>ASHTON</b>		<b>CONSORT</b>		<b>ABBEY</b>		<b>CUMBERLAND</b>		<b>PRESIDENT</b>		<b>SOLSTICE</b>		
Min size (w x h): 2134 x 1981 (7'0" x 6'6")	Min size (w x h): 2134 x 1981 (7'0" x 6'6")		Min size (w x h): 2134 x 1981 (7'0" x 6'6")		Min size (w x h): 2134 x 1981 (7'0" x 6'6")		Min size (w x h): 2134 x 1981 (7'0" x 6'6")		Min size (w x h): 2134 x 1981 (7'0" x 6'6")		Min size (w x h): 2134 x 1981 (7'0" x 6'6")		Min size (w x h): 2134 x 1981 (7'0" x 6'6")		
WIDTH x HEIGHT METRIC IMPERIAL	CANOPY	TRACKED	CANOPY	TRACKED	CANOPY	TRACKED	CANOPY	TRACKED	CANOPY	TRACKED	CANOPY	TRACKED	CANOPY	TRACKED	
2134 x 2286	7'0" x 7'6"	1458	1498	1478	1518	1137	1177	1331	1371	1422	1462	1452	1492	1257	1297
2286 x 2286	7'6" x 7'6"	1641	1681	1629	1669	1347	1387	1532	1572	1575	1615	1567	1607	1483	1523
2438 x 2286	8'0" x 7'6"	1641	1681	1629	1669	1347	1387	1532	1572	1575	1615	1567	1607	1483	1523
2591 x 2286	8'6" x 7'6"	-	1858	-	-	-	1530	-	1686	-	1728	-	-	-	-
2743 x 2286	9'0" x 7'6"	-	1858	-	-	-	1530	-	1686	-	1728	-	-	-	-
2895 x 2286	9'6" x 7'6"	-	1949	-	-	-	1670	-	1855	-	1931	-	-	-	-
3048 x 2286	10'0" x 7'6"	-	1949	-	-	-	1670	-	1855	-	1931	-	-	-	-
3353 x 2286	11'0" x 7'6"	-	2159	-	-	-	1796	-	2036	-	2140	-	-	-	-
3658 x 2286	12'0" x 7'6"	-	2354	-	-	-	1948	-	2243	-	2354	-	-	-	-
3962 x 2286	13'0" x 7'6"	-	2524	-	-	-	2127	-	2469	-	2484	-	-	-	-
4267 x 2286	14'0" x 7'6"	-	2639	-	-	-	2284	-	2716	-	2658	-	-	-	-
4572 x 2286	15'0" x 7'6"	-	2775	-	3013	-	2408	-	2987	-	2917	-	-	-	-

Note: Styles over 7'0" (2134mm) high may differ slightly in design to those below 7'0" (2134mm) in height - please request confirmation.

- 4 FOUR POINT LOCKING**  
Available from February.  
To convert existing 2 point locking system to 4 point locking (Kit supplied)  
● For single doors Add **£26**  
● For double doors Add **£41**

- V VISION WINDOWS**  
● For single doors Add **£255**  
● For double doors Add **£510**

- H HANDLE OPTIONS**  
● Brass effect Add **£42**  
Available until Feb 1st.

All illustrations shown are for 7' wide x 7' high single doors.

# G60 SECTIONAL DOORS - MANUAL OPERATION

## STANDARD SINGLE & DOUBLE SIZES

### STANDARD SINGLE SIZES

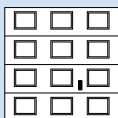

GEORGIAN

**C B R V LO F H S**

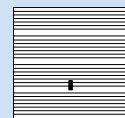

RIBBED

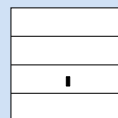

STYLE

**C B R V LO F H S**

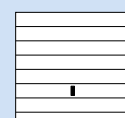

TREND

**C B R V LO F H S**

#### OPTIONS

ORDER NUMBER	WIDTH x HEIGHT METRIC IMPERIAL	TENSION GEAR	TORSION GEAR	EMBOSSES x PANELS
7066	2134 x 2000 7'0" x 6'6"	1031	1081	3x4
7070	2134 x 2125 7'0" x 7'0"	1041	1091	3x4
7666	2286 x 2000 7'6" x 6'6"	1120	1170	3x4
7670	2286 x 2125 7'6" x 7'0"	1120	1170	3x4
8066	2438 x 2000 8'0" x 6'6"	1137	1187	3x4
8070	2438 x 2125 8'0" x 7'0"	1137	1187	3x4
8666	2591 x 2000 8'6" x 6'6"	1205	1255	4x4
8670	2591 x 2125 8'6" x 7'0"	1205	1255	4x4
9066	2743 x 2000 9'0" x 6'6"	1254	1304	4x4
9070	2743 x 2125 9'0" x 7'0"	1254	1304	4x4
9666	2895 x 2000 9'6" x 6'6"	1397	1447	4x4
9670	2895 x 2125 9'6" x 7'0"	1397	1447	4x4

TENSION GEAR	TORSION GEAR	PANELS
848	898	4
848	898	4
871	921	4
889	939	4
894	944	4
894	944	4
929	979	4
929	979	4
953	1003	4
953	1003	4
998	1048	4
998	1048	4

TENSION GEAR	TORSION GEAR	PANELS
1049	1099	4
1049	1099	4
1098	1148	4
1121	1171	4
1098	1148	4
1121	1171	4
1145	1195	4
1168	1218	4
1145	1195	4
1168	1218	4
1199	1249	4
1222	1272	4

### STANDARD DOUBLE SIZES

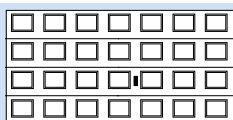

GEORGIAN

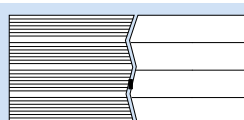

RIBBED/STYLE

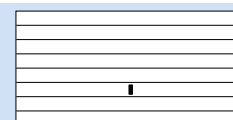

TREND

ORDER NUMBER	WIDTH x HEIGHT METRIC IMPERIAL	TENSION GEAR	TORSION GEAR	EMBOSSES x PANELS
1066	3048 x 2000 10'0" x 6'6"	-	1667	4x4
1070	3048 x 2125 10'0" x 7'0"	-	1667	4x4
1266	3658 x 2000 12'0" x 6'6"	-	1827	6x4
1270	3658 x 2125 12'0" x 7'0"	-	1827	6x4
1366	3962 x 2000 13'0" x 6'6"	-	1827	6x4
1370	3962 x 2125 13'0" x 7'0"	-	1827	6x4
1466	4267 x 2000 14'0" x 6'6"	-	1827	7x4
1470	4267 x 2125 14'0" x 7'0"	-	1827	7x4
14666	4420 x 2000 14'6" x 6'6"	-	1859	7x4
14670	4420 x 2125 14'6" x 7'0"	-	1889	7x4
1666	4876 x 2000 16'0" x 6'6"	-	1939	7x4
1670	4876 x 2125 16'0" x 7'0"	-	1979	7x4

TENSION GEAR	TORSION GEAR	PANELS
-	1197	4
-	1218	4
-	1505	4
-	1505	4
-	1536	4
-	1536	4
-	1471	4
-	1499	4
-	1532	4
-	1532	4
-	1682	4
-	1682	4

TENSION GEAR	TORSION GEAR	PANELS
-	1503	4
-	1529	4
-	1589	4
-	1618	4
-	1704	4
-	1735	4
-	1854	4
-	1889	4
-	1854	4
-	1889	4
-	1939	4
-	1978	4

Prices shown include fully finished White paint.

Prices shown do not include manual locking - see handle options if required.

### OPTIONS AVAILABLE - g60 SECTIONAL DOORS

#### **B** FULLY FINISHED BROWN

- Doors up to and including 3000mm wide Add **£0**
- Doors over 3000mm wide Add **£0**

Note: All doors are White on the inside.

#### **R** FULLY FINISHED TO A RAL COLOUR OF YOUR CHOICE

- Add **£45** per metre<sup>2</sup>

Note: All doors are White on the inside.

#### **F** FRAMED DOORS

- Doors up to and including 2375mm high Add **£35**

The frame consists of 2 steel frame L section legs and fittings to install between the reveal

#### **C** POPULAR COLOURS

- Doors up to and including 3000mm wide Add **£45** per metre<sup>2</sup>
- Doors over 3000mm wide Add **£45** per metre<sup>2</sup>

Colours available : White Aluminium (RAL 9006); Green (RAL 6005); Anthracite Grey (RAL 7016); Loam Brown (RAL 8003); Light Grey (RAL 7035); Cream White (RAL 9001)

Note: All doors are White on the inside.

#### **V** VISION WINDOWS (Clear or milky glass)

- Doors up to and including 3000mm wide Add **£243**
- Doors over 3000mm wide Add **£485**

Note: State window design and choice of glass when ordering. Window cassettes painted to match the door colour.



#### **LO** LOW HEADROOM TENSION AND TORSION KITS

- Doors up to and including 3000mm wide Add **£82**
- Doors over 3000mm wide (torsion only) Add **£82**

Note: All doors with heights of 2650mm, 2800mm and 3000mm are supplied with low headroom torsion gear as standard at no extra cost.

#### **S** LAMINATE STEEL FINISH

- Doors up to and including 3000mm wide Add **£150**
- Doors over 3000mm wide (torsion only) Add **£275**

Note: Golden Oak finish to the exterior panel face. This finish is available in Woodgrain only. Laminate finish available in Georgian, Ribbed, Trend and Style.

#### **H** HANDLE OPTIONS

- Manual Locking Kit Add **£30**  
(Includes black plastic handle and locking system for on-site fitting, cutting template supplied)
- For silver aluminium handle Add **£37**
- For gold effect handle Add **£86**
- For stainless steel handle Add **£115**

#### **WOODGRAIN**

Doors are supplied as standard in a Diamond pattern finish. Models g60 Ribbed, Trend and Style also available when stated in woodgrain finish at no extra cost.

# G60 SECTIONAL DOORS - MANUAL OPERATION

MADE TO MEASURE SIZES

**FOR MADE TO MEASURE SIZES TAKE THE NEXT SIZE UP FROM THE TABLES ON THE LEFT HAND PAGE AND ADD:**

**MADE TO MEASURE SIZES**

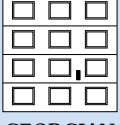

GEORGIAN

**OPTIONS**

**C B R V L O F H S**

NUMBER OF EMBOSSES PER DOOR PANEL

up to 2399mm = 3	up to 3099mm = 4	up to 3649mm = 5	up to 4249mm = 6	up to 5000mm = 7
------------------	------------------	------------------	------------------	------------------

WIDTH	1800	2000	2250	2500	2750	3000	3250	3500	3750	4000	4250	4500	4750	5000	NUMBER OF DOOR PANELS
HEIGHT 1900														POA	4
2000														POA	4
2125														POA	4
2250														POA	4
2375														POA	5
2500														POA	5
2650												x	x	x	5
2800												x	x	x	5
3000												x	x	x	6

**MADE TO MEASURE SIZES**

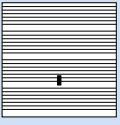

RIBBED

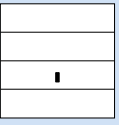

STYLE

**OPTIONS**

**C B R V L O F H S**

WIDTH	1800	2000	2250	2500	2750	3000	3250	3500	3750	4000	4250	4500	4750	5000	NUMBER OF DOOR PANELS
HEIGHT 1900														POA	4
2000														POA	4
2125														POA	4
2250														POA	4
2375														POA	5
2500														POA	5
2650												x	x	x	5
2800												x	x	x	5
3000												x	x	x	6

**MADE TO MEASURE SIZES**

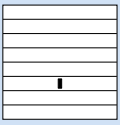

TREND

**OPTIONS**

**C B R V L O F H S**

WIDTH	1800	2000	2250	2500	2750	3000	3250	3500	3750	4000	4250	4500	4750	5000	NUMBER OF DOOR PANELS
HEIGHT 1900														POA	4
2000														POA	4
2125														POA	4
2250														POA	4
2375														POA	5
2500														POA	5
2650												x	x	x	5
2800												x	x	x	5
3000												x	x	x	6

For sizes over 4876mm wide - Price on application

# G60 SIDE DOORS

STANDARD & MADE TO MEASURE SIZES

**STANDARD SIZES**

**OPTIONS**

SIZE WIDTH x HEIGHT	OUTSIDE FRAME SIZE WIDTH x HEIGHT	FRAMED DOOR PRICE	FRAMED DOOR PRICE	FRAMED DOOR PRICE
1000 x 2000	1136 x 2068	671	574	574
875 x 2125	1011 x 2193	646	548	548
875 x 2000	1011 x 2068	646	548	548
1000 x 2125	1136 x 2193	671	574	574

**MADE TO MEASURE SIZES**

714-964 x 1935-2032	850-1100 x 2003-2100	686	588	588
965-1114 x 2033-2135	1101-1250 x 2101-2203	711	614	614

**C** Add 65   **B** Add 45   **R** Add 85   **V** Add 65

**OPERATING GEAR FOR MADE TO MEASURE SIZES**

 Doors in this light shaded area (up to 3000mm wide x 2500mm high) are supplied with standard tension gear. For low headroom tension gear:- Add **£82** to the prices shown. For torsion gear:- Add **£82** to the prices shown. For low headroom torsion gear:- Add **£145** to the prices shown.

 Doors in this darker shaded area are supplied with standard torsion gear. For low headroom torsion gear Add **£82** to the prices shown.

 Doors in this grey shaded area are supplied with low headroom torsion gear as standard.

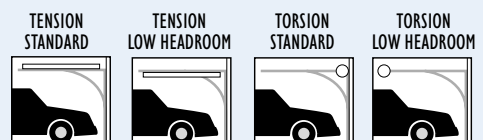

**IMPORTANT: SEE 'ORDERING NOTES' ON PAGE 18.**

All illustrations shown are for 7' wide x 7' high single doors and 14' wide x 7' high double doors.

# INSULATED 77

## THE ULTIMATE CHOICE INSULATED ROLLER GARAGE DOORS

Sizes listed are the ordering sizes. These are the over guide widths and guide heights.

### COLOURED FINISH

Guide Height (up to)		Over Guide Width (up to)							70mm guides (each side) and 270mm headroom
		2000mm 6'6 3/4"	2500mm 8'2 3/8"	3000mm 9'10 1/8"	3500mm 11'5 3/4"	4000mm 13'1 1/2"	4600mm 15'1 1/8"	5200mm 17'0 3/4"	
METRIC	IMPERIAL								95mm guides (each side) and 300mm headroom
1981mm	(6'6")	1130	1207	1325	1419	1617	1797	1999	
2134mm	(7'0")	1130	1207	1325	1419	1617	1797	1999	
2286mm	(7'6")	1165	1243	1360	1454	1715	1825	2115	
2438mm	(8'0")	1190	1268	1444	1479	1715	1945	2130	
2590mm	(8'6")	1291	1422	1522	1588	1885	2030	2325	
2743mm	(9'0")	1311	1442	1522	1588	1922	2250	2450	
3000mm	(9'10")	1311	1442	1565	1588	1922	2300	-	

Sizes listed are the ordering sizes. These are the over guide widths and guide heights. \*Guide heights of over 2500mm supplied with 95mm guides

### WOODGRAIN FINISH

Guide Height (up to)		Over Guide Width (up to)							95mm guides (each side) and 300mm headroom
		2000mm 6'6 3/4"	2500mm 8'2 3/8"	3000mm 9'10 1/8"	3500mm 11'5 3/4"	4000mm 13'1 1/2"	4600mm 15'1 1/8"	5200mm 17'0 3/4"	
METRIC	IMPERIAL								
1981mm	(6'6")	1326	1470	1640	1779	2044	2299	2547	
2134mm	(7'0")	1453	1470	1640	1779	2044	2300	2565	
2286mm	(7'6")	1495	1535	1705	1844	2099	2365	2630	
2438mm	(8'0")	1545	1570	1803	1904	2195	2525	2768	
2590mm	(8'6")	1685	1810	1922	2103	2425	2695	2905	
2743mm	(9'0")	1795	1810	1922	2103	2475	2695	3255	
3000mm	(9'10")	1835	1850	1922	2103	2475	2795	-	

Sizes listed are the ordering sizes. These are the over guide widths and guide heights. \*Guide heights of over 2500mm supplied with 95mm guides

### OPTIONS Add size supplement to door price

90° half curtain roll box*	104	109	121	132	144	156	170
Full curtain roll box*	159	166	187	210	233	260	286
Vision Slats	46	48	58	68	76	89	99

\*Roll box requires 300mm endplates and 95mm guides

### INSULATED 77 FINISHES

#### Low maintenance Powdercoat or high grade woodgrain laminate

Brilliant White RAL9010, Buttermilk RAL9001, Cream RAL1015, Jade RAL6021, Mocca RAL8019, Blue RAL5011, Racing Green RAL6009, Burgundy RAL3004, Anthracite Grey RAL7016, Black BS00E53, Metallic Silver RAL9006 and Teak.

#### Low maintenance high grade woodgrain laminate

Dark Oak, Rosewood, Golden Oak, Mahogany, Dark Blue Woodgrain and Dark Green Woodgrain.

Please note that the colour of the bottom lath may vary slightly from the rest of the door. Teak doors are supplied with a solid brown bottom lath.

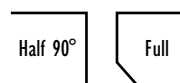

Colour matched Roll boxes are available in White, Mocca, Buttermilk, Racing Green, Burgundy, Blue, Black, Cream, Jade, Anthracite Grey and Metallic Silver.

See surcharges as listed above. Roll box colour will match door: Teak and Woodgrain finished doors will be supplied with a Mocca roll box.

### BUILD OPTIONS - INSULATED 77

Milled Finish	Minus <b>£30</b>	Wired door status indicator & switch	Add <b>£55</b>
Emergency external manual override	Add <b>£121</b>	Photocell kit	Add <b>£118</b>
Lockable Override Cover	Add <b>£34</b>	Parking sensor kit	Add <b>£219</b>
Additional keyring handset (8 channel)	Add <b>£70</b>	Auto-close module	Add <b>£55</b>
Wired up/down wall switch	Add <b>£22</b>	Battery Backup doors <11m²	Add <b>£325</b>
Wireless up/down wall switch	Add <b>£66</b>	Battery Backup doors >11m²	Add <b>£401</b>
Wired key switch	Add <b>£61</b>	Battery Backup bracket	Add <b>£28</b>
Wireless key switch	Add <b>£130</b>	Relay unit (gate control)	Add <b>£217</b>
Wireless keypad	Add <b>£182</b>	Touch up paint	Add <b>£28</b>

# INSULATED 55

## THE COMPACT CHOICE INSULATED ROLLER GARAGE DOORS

Sizes listed are the ordering sizes. These are the over guide widths and guide heights.

### COLOURED FINISH EXTERNAL FIT

Guide Height (up to)		Over Guide Width (up to)			
		2134mm 7'0"	2286mm 7'6"	2450mm 8'0 1/2"	3000mm 9'10"
METRIC	IMPERIAL				
1981mm	(6'6")	1342	1342	1342	1455
2134mm	(7'0")	1342	1342	1342	1455
2438mm	(8'0")	1445	1445	1445	1595

Full roll box as standard

### INSULATED 55 MANUAL

Over Guide Width (up to)			
2134mm 7'0"	2286mm 7'6"	2450mm 8'0 1/2"	3000mm 9'10"
893	961	1019	1113
935	993	1040	1134
977	1035	1155	1208

Full matching roll box and guides as standard

### COLOURED FINISH INTERNAL FIT

Guide Height (up to)		Over Guide Width (up to)			
		2134mm 7'0"	2286mm 7'6"	2450mm 8'0 1/2"	3000mm 9'10"
METRIC	IMPERIAL				
1981mm	(6'6")	1262	1262	1262	1375
2134mm	(7'0")	1262	1262	1262	1375
2438mm	(8'0")	1365	1365	1365	1515

Full roll box as an option

Over Guide Width (up to)			
2134mm 7'0"	2286mm 7'6"	2450mm 8'0 1/2"	3000mm 9'10"
893	961	1019	1113
935	993	1040	1134
977	1035	1155	1208

Full matching roll box and guides as standard

### WOODGRAIN FINISH INTERNAL FIT

Guide Height (up to)		Over Guide Width (up to)			
		2134mm 7'0"	2286mm 7'6"	2450mm 8'0 1/2"	3000mm 9'10"
METRIC	IMPERIAL				
1981mm	(6'6")	1490	1561	1561	1824
2134mm	(7'0")	1490	1561	1561	1824
2438mm	(8'0")	1712	1712	1712	1948

Full roll box as an option

The Insulated 55 Manual is a spring assisted version of the Insulated 55. It includes a locking slat in the lower half of the door which is flat in profile and will vary slightly in colour from the curtain slats.

The Insulated 55 Manual has a full roll box as standard.

### INSULATED 55 FINISHES

#### Low maintenance Powdercoat

Brilliant White RAL9010, Mocca RAL8019, Cream RAL1015, Racing Green RAL6009, Black BS00E53, Metallic Bronze and Metallic Silver:

#### Low maintenance high grade woodgrain laminate

Golden Oak and Mahogany, both available on internal fit doors only.

Please note that the colour of the bottom lath may vary slightly from the rest of the door. Metallic Bronze doors are supplied with a solid brown bottom lath, guides and roll box.

\*Woodgrain doors are only available with white, mocca, racing green, metallic silver, cream and black guides. A full roll box is supplied as standard on external fit doors - specify colour with order. A 90° half roll box is supplied as standard on internal fit doors - specify colour with order.

### INSULATED 55 MANUAL FINISHES

#### Low maintenance Powdercoat

Brilliant White RAL9010 and Mocca RAL8019 only,

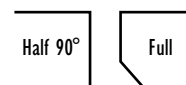

Colour matched Roll boxes are available in White, Mocca, Racing Green, Black, Cream and Metallic Silver: Full roll box supplied as standard on external fit doors, half box supplied as standard on internal fit doors.

### BUILD OPTIONS - INSULATED 55

Full roll box on internal fit doors	Use External fit price	Wireless keypad	Add	£182
Colour matched guides*	Add	Wired door status indicator & switch	Add	£55
Emergency external manual override	Add	Photocell kit	Add	£118
Lockable Override Cover	Add	Parking sensor kit	Add	£219
Additional keyring handset (8 channel)	Add	Auto-close module	Add	£55
Wired up/down wall switch	Add	Battery Backup doors < 11m <sup>2</sup>	Add	£325
Wireless up/down wall switch	Add	Battery Backup bracket	Add	£28
Wired key switch	Add	Relay unit (gate control)	Add	£217
Wireless key switch	Add	Touch up paint	Add	£28

All illustrations shown are for 7' wide x 7' high single doors.

# ROLLER DOORS

SERIES		CURTAIN WIDTH											
		'A' SERIES								'AA' SERIES			
HEIGHT METRIC	HEIGHT IMPERIAL	1270	1880	2185	2337	2490	2640	2800	3100	3400	3760	4370	5100
		(4'2")	(6'2")	(7'2")	(7'7 <sup>7</sup> / <sub>8</sub> ")	(8'2")	(8'7 <sup>5</sup> / <sub>8</sub> ")	(9'2 <sup>1</sup> / <sub>4</sub> ")	(10'2")	(11'1 <sup>7</sup> / <sub>8</sub> ")	(12'4")	(14'4")	(16'8 <sup>3</sup> / <sub>4</sub> ")
1829 to 2133	(6'0" - 7'0")	502	506	506	518	546	573	591	690	805	985	1131	1339
2160 to 2440	(7'1" - 8'0")	564	567	567	579	598	621	647	738	862	1077	1288	1458
2465 to 2745	(8'1" - 9'0")	614	634	634	653	687	703	727	823	941	1188	1344	1552
2770 to 3000	(9'1" - 9'10")	659	699	717	749	784	789	806	907	1061	1293	1476	1582
Weathergrain finish add:		65	65	97	97	97	128	128	128	128	222	222	222

## ROLLER MINI - reduced headroom requirement

Prices shown for Plastisol Finish

1829 to 2133	(6'0" - 7'0")	-	510	510	525	545	565	585	-	-	-	-	-
Weathergrain finish add:		-	65	97	97	97	128	128	-	-	-	-	-

**Door Sizing:** 'A' Series = Doors up to 3710mm wide. 'AA' Series = Doors over 3760mm wide

## AUTOMATION

Complete with two, four channel handsets.

Motors also suitable as retrofit.

Henderson Operator **345**

### Automation Options

Additional Mini Transmitter 4 channel	59
Electric Key Switch	32
External Manual Release Kit	20
Wireless Wall Control	48
Beam Break	48
Wireless Keypad	67
Wireless Fingerprint Scanner	144
Motion detector Control Panel	40
Battery Backup System	136

## BUILD OPTIONS

Reverse Roll	74
Steel Wrap	86
Rollguard Security Package	146
Infill Panels per linear metre	37
Removable Centre Mullions	93
Chain Kits (for high openings)	196

## OPTIONS AVAILABLE

### COLOUR OPTIONS

#### High Performance Plastisol

Brilliant White, Olive Green, Black and Van Dyke Brown

#### Woodgrain Laminate

Golden Oak and Rosewood (requires supplement, see table).

## ORDERING NOTES

**Ordering Notes:** Henderson Roller Doors are designed to fit behind the brickwork opening to give a clear drive through width\*. To order, state the curtain size, ensuring that the curtain width is greater than the opening by: 'A' series: 50 mm (2") minimum, 'AA' series: 100mm (4") minimum. For example, to order a door for a brickwork opening width of 7'0", order an 'A' series door with curtain width minimum of 7'2".

**Made to Measure Sizes:** Any size door can be supplied. Any size of garage door falling within each band is priced at the upper limit of the band **with a £40 supplement added.**

**Packaging:** Henderson Roller Doors are factory 'bubble wrapped' as standard for increased protection during transit.

\* The drive through height is 80mm less than the nominal opening height.

# REMOTE CONTROL SYSTEMS



**ULTRA EXCELLENT** £505

ULTRA EXCELLENT LONG  
For doors over 8' high:

£525



**ULTRA** £421

ULTRA LONG  
For doors over 8' high:

£442



**ULTRA S** £342

ULTRA S LONG  
For doors over 8' high:

£362

## OPTIONAL EXTRAS FOR ULTRA REMOTE CONTROL OPERATORS

	Part Number	£
<b>Two function transmitter</b>		
433Mhz	024166	£50
<b>Four function transmitter</b>		
433Mhz	014055	£50
<b>Digital key pad entry system</b>		
- radio operated 433Mhz	014146	£99
<b>Keyed switch entry system</b>		
- surface mounted 1 Channel	014134	£34
- surface mounted 2 Channel	014135	£34
- flush mounted 1 Channel	014136	£34
- flush mounted 2 Channel	014137	£34
<b>Photocell light barrier</b>		
- surface mounted	014138	£70
- flush mounted	014545	£70
<b>Bowden cable</b>		
(allows the operator to be disengaged from outside using the existing garage door locking system)		
- g60 sectional doors	014061	£18
- up and over doors	014546	£18
<b>Exterior release mechanism</b>		
(as above, but where the door has no lock or handle)		
- g60 sectional doors	014544	£30
- up and over doors	014544	£30
<b>Bow arm converter system</b>		
(see information panel below)		
	014655	£71
<b>De-latching kit</b>		
- up and over doors	014062	£36
<b>Wall mounted push button and cable</b>	014139	£16
<b>Antennae 433Mhz</b>	014132	£26
<b>Wall mounted transmitter holder</b>	014133	£6

## BOW ARM CONVERTER SYSTEM

If your door has canopy lifting gear, you will require a Bow Arm Converter System to enable a manual door to be used with a remote control operator.

The Bow Arm Converter is suitable for use with single size doors up to a maximum size of 2743mm (9ft) wide. The Bow Arm Converter system cannot be used when the operator boom is mounted further than 3 inches from the back face of the garage door. Use of a Bow Arm will reduce the drive through height of the garage by approximately 6"

# TECHNICAL

## CANOPY GEAR

### STANDARD DOOR AND BRICKWORK APERTURE SIZES

- It is recommended that Locklift Canopy is fitted to a weatherbeaded 70mm x 70mm timber "goalpost" frame, although the door can be fitted to a smaller side jamb down to a minimum of 45 mm wide. This frame is not supplied. A Henderson garage doors Quick-fit steel frame can also be used. Locklift Canopy steel framed dimensions are 54 mm wide on side section, 68 mm high on top section and 35 mm deep all round, plus there is also an option of a 68mm wide side jamb.
- The minimum headroom required above the lower face of the top timber or lintel is 65 mm.

### NOTES

Door sizes given represent opening sizes within the frame. Door leaves are approximately 19 mm narrower and 25 mm shorter to allow for operating clearances and tolerances. 'Within the brickwork' aperture dimensions include a 3 mm gap between the frame and brickwork on all three sides to allow for coursing and tolerances. 'Behind the brickwork' aperture dimensions allow the frame to overlap into the aperture by a minimum of 13 mm on both sides to allow for coursing and tolerances.

### BRICKWORK APERTURE SIZES FOR FRAMES FITTED WITHIN THE OPENING

Size code	Door size width x height	Timber frame (70x70mm)	54mm Quick-fit steel frame	68mm Quick-fit steel frame
		Brickwork aperture width x height	Brickwork aperture width x height	Brickwork aperture width x height
6666	1981 x 1981mm	2127 x 2054mm	2095 x 2052mm	2123 x 2052mm
6670	1981 x 2134mm	2127 x 2207mm	2095 x 2205mm	2123 x 2205mm
7066	2134 x 1981mm	2280 x 2054mm	2248 x 2052mm	2276 x 2052mm
7070	2134 x 2134mm	2280 x 2207mm	2248 x 2205mm	2276 x 2205mm
7364	2222 x 1930mm	2368 x 2003mm	2336 x 2001mm	2364 x 2001mm
7566	2261 x 1981mm	2407 x 2054mm	2375 x 2052mm	2403 x 2052mm
7570	2261 x 2134mm	2407 x 2207mm	2375 x 2205mm	2403 x 2205mm
7666	2286 x 1981mm	2432 x 2054mm	2400 x 2052mm	2428 x 2052mm
7670	2286 x 2134mm	2432 x 2207mm	2400 x 2205mm	2428 x 2205mm
8066	2438 x 1981mm	2584 x 2054mm	2552 x 2052mm	2580 x 2052mm
8070	2438 x 2134mm	2584 x 2207mm	2552 x 2205mm	2580 x 2205mm

### BRICKWORK APERTURE SIZES FOR FRAMES FITTED BEHIND THE OPENING

Size code	Door size width x height	Timber frame (70x70mm)	54mm Quick-fit steel frame	68mm Quick-fit steel frame
		Brickwork aperture width x height	Brickwork aperture width x height	Brickwork aperture width x height
6666	1981 x 1981mm	2007 x 1981mm	2007 x 1981mm	2007 x 1981mm
6670	1981 x 2134mm	2007 x 2134mm	2007 x 2134mm	2007 x 2134mm
7066	2134 x 1981mm	2160 x 1981mm	2160 x 1981mm	2160 x 1981mm
7070	2134 x 2134mm	2160 x 2134mm	2160 x 2134mm	2160 x 2134mm
7364	2222 x 1930mm	2248 x 1930mm	2248 x 1930mm	2248 x 1930mm
7566	2261 x 1981mm	2287 x 1981mm	2287 x 1981mm	2287 x 1981mm
7570	2261 x 2134mm	2287 x 2134mm	2287 x 2134mm	2287 x 2134mm
7666	2286 x 1981mm	2312 x 1981mm	2312 x 1981mm	2312 x 1981mm
7670	2286 x 2134mm	2312 x 2134mm	2312 x 2134mm	2312 x 2134mm
8066	2438 x 1981mm	2464 x 1981mm	2464 x 1981mm	2464 x 1981mm
8070	2438 x 2134mm	2464 x 2134mm	2464 x 2134mm	2464 x 2134mm

### FITTING FRAMES TO THE BRICKWORK

Frames may be fitted within or behind the brickwork. Fitting behind the brickwork, if the garage length allows, will increase the drive-through width by up to 114 mm (4 1/2").

A 19 mm x 19 mm weatherbead should always be fitted to the under-side of the door frame lintel in front of the door to hide the top gap. This feature is integral on the Henderson garage doors Quick-fit steel frame.

Canopy doors are quick and easy to install and take up less space in the garage when opening.

Canopy lifting gear is available for single sized doors up to 2438 mm (8'0") wide and 2134 mm (7'0") high only.

# TECHNICAL

## CANOPY GEAR

### FITTING FRAMES TO THE BRICKWORK

Fitting to timber frame, within the brickwork aperture

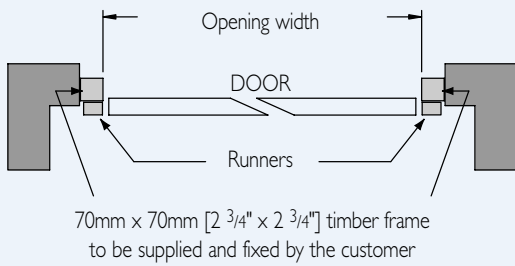

Fitting to timber frame, behind the brickwork aperture

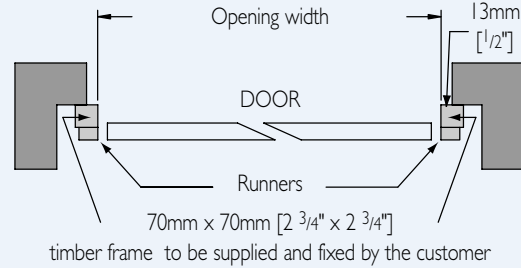

Fitting to 54 mm Quick-fit steel Locklift frame, within the brickwork aperture

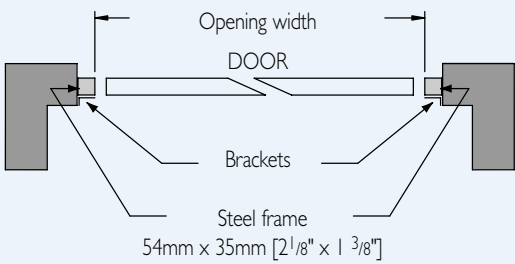

Fitting to 54 mm Quick-fit steel Locklift frame, behind the brickwork aperture

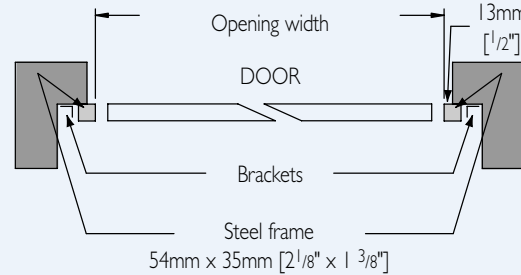

Fitting to 68 mm Quick-fit steel Locklift frame, within the brickwork aperture

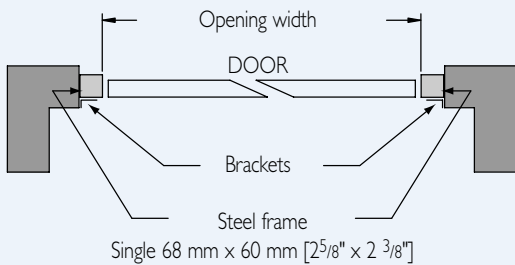

Fitting to 68 mm Quick-fit steel Locklift frame, behind the brickwork aperture

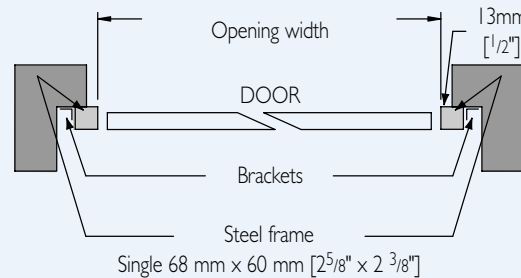

### OPENING ARCS OF TRAVEL

1981 mm [6'6"] high Trackless Canopy doors

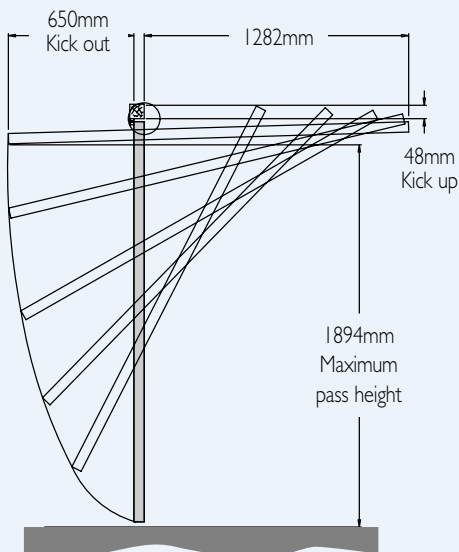

2134 mm [7'0"] high Trackless Canopy doors

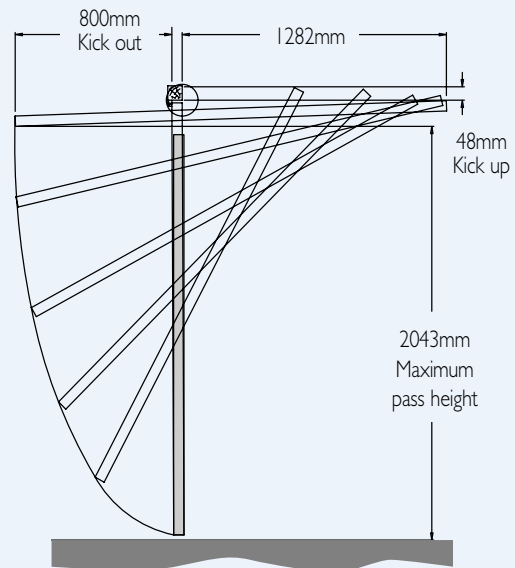

# TECHNICAL

## RETRACTABLE GEAR

### STANDARD DOOR AND BRICKWORK APERTURE SIZES

- Henderson garage doors Locklift Retractable door gear should be fitted to a weatherbeaded 70 mm x 70 mm standard timber 'goalpost' frame (not supplied). Alternatively retractable single and double doors up to 4876 mm may be fitted to a Henderson garage doors Quick-fit steel retractable frame (single door dimensions = 68 mm wide by 60mm deep all round, double door dimensions = 68 mm wide x 75 mm deep all round).
- The minimum headroom required above the lower face of the top timber or lintel is 43mm for double doors, 38.5 mm for single doors.

### NOTES

- Door sizes given are for opening sizes within the frame. Door leaves are approximately 19 mm narrower and 25 mm shorter than the dimensions given to allow for clearances and tolerances.
- In use, single and double retractable lifting gear reduces drive through width by 114mm (4 1/2") and height by 127 mm (5").
- 'Within the brickwork' aperture dimensions include a 3 mm gap between the frame and brickwork on all three sides to allow for coursing and tolerances.
- 'Behind the brickwork' aperture dimensions allow the frame to overlap into the aperture by 13 mm on both sides to allow for coursing and tolerances.
- Retractable frames for single and double doors are also available 7'6" high for single doors and 8'0" high for double doors.
- Special size frames are available in any size from 6'6" x 6'1" to 16' 0" x 8'0".

### BRICKWORK APERTURE SIZES FOR FRAMES FITTED WITHIN THE OPENING

Size code	Door size width x height	Timber frame (70x70mm)	Quick-fit steel frame
		Brickwork aperture width x height	Brickwork aperture width x height
6666	1981 x 1981mm	2127 x 2054mm	2123 x 2052mm
6670	1981 x 2134mm	2127 x 2207mm	2123 x 2205mm
7066	2134 x 1981mm	2280 x 2054mm	2276 x 2052mm
7070	2134 x 2134mm	2280 x 2207mm	2276 x 2205mm
7364	2222 x 1930mm	2368 x 2003mm	2364 x 2001mm
7566	2261 x 1981mm	2407 x 2054mm	2403 x 2052mm
7570	2261 x 2134mm	2407 x 2207mm	2403 x 2205mm
7666	2286 x 1981mm	2432 x 2054mm	2428 x 2052mm
7670	2286 x 2134mm	2432 x 2207mm	2428 x 2205mm
8066	2438 x 1981mm	2584 x 2054mm	2580 x 2052mm
8070	2438 x 2134mm	2584 x 2207mm	2580 x 2205mm
1466	4267 x 1981mm	4413 x 2054mm	4413 x 2052mm
1470	4267 x 2134mm	4413 x 2207mm	4413 x 2205mm

### BRICKWORK APERTURE SIZES FOR FRAMES FITTED BEHIND THE OPENING

Size code	Door size width x height	Timber frame (70x70mm)	54mm Quick-fit steel frame
		Brickwork aperture width x height	Brickwork aperture width x height
6666	1981 x 1981mm	2007 x 1981mm	2007 x 1981mm
6670	1981 x 2134mm	2007 x 2134mm	2007 x 2134mm
7066	2134 x 1981mm	2160 x 1981mm	2160 x 1981mm
7070	2134 x 2134mm	2160 x 2134mm	2160 x 2134mm
7364	2222 x 1930mm	2248 x 1930mm	2248 x 1930mm
7566	2261 x 1981mm	2287 x 1981mm	2287 x 1981mm
7570	2261 x 2134mm	2287 x 2134mm	2287 x 2134mm
7666	2286 x 1981mm	2312 x 1981mm	2312 x 1981mm
7670	2286 x 2134mm	2312 x 2134mm	2312 x 2134mm
8066	2438 x 1981mm	2464 x 1981mm	2464 x 1981mm
8070	2438 x 2134mm	2464 x 2134mm	2464 x 2134mm
1466	4267 x 1981mm	4293 x 1981mm	4293 x 1981mm
1470	4267 x 2134mm	4293 x 2134mm	4293 x 2134mm

### DRIVE-THROUGH CLEARANCES

(Double sized retractable doors up to 4876 mm (16' 0") wide by 2286 mm (7'6") high only)

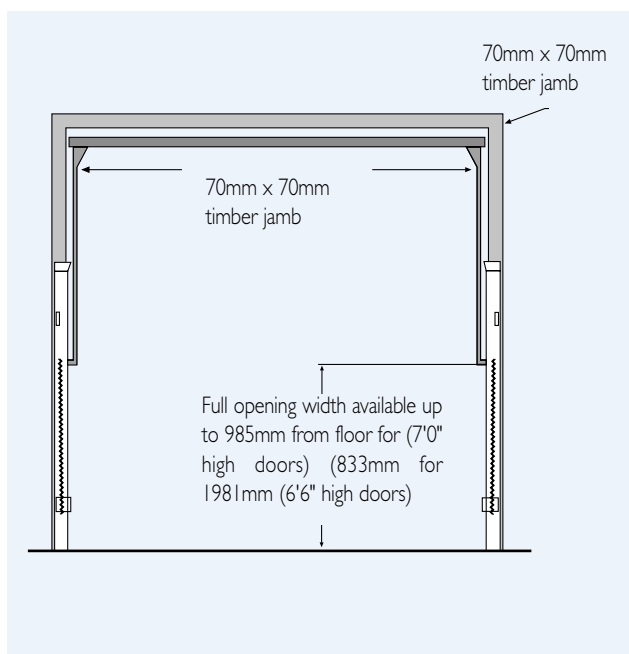

### DRIVE-THROUGH CLEARANCES

(single sized retractable doors up to 2438 mm (8'0") wide by 2286 mm (7'6") high only).

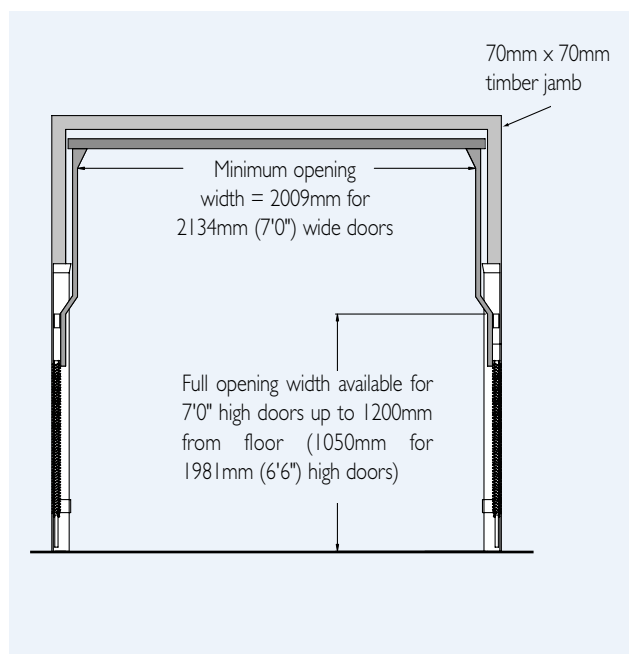

# TECHNICAL

## RETRACTABLE GEAR

### FITTING FRAMES TO THE BRICKWORK

Frames may be fitted within or behind the brickwork as per the drawings shown. Fitting behind the brickwork, if the garage length allows, will increase drive-through width by up to 114 mm (4 1/2").

A 19 mm x 19 mm weatherbead should be fitted to the underside of the door frame lintel in front of the door to hide the top gap. This feature is integral on the Quick-fit steel frame.

Retractable doors offer exceptionally smooth opening action and are ideal for electric operation.

### FITTING FRAMES TO THE BRICKWORK

Fitting to timber frame, within the brickwork aperture

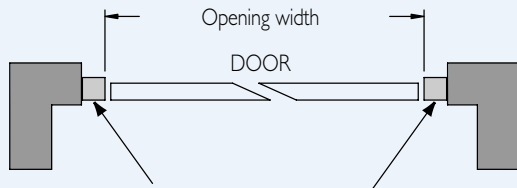

70mm x 70mm [2 3/4" x 2 3/4"] timber frame to be supplied and fixed by the customer

Fitting to timber frame, behind the brickwork aperture

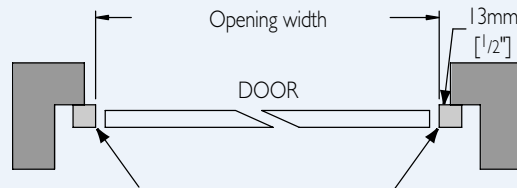

70mm x 70mm [2 3/4" x 2 3/4"] timber frame to be supplied and fixed by the customer

Fitting to Quick-fit steel Retractable frame, within the brickwork aperture

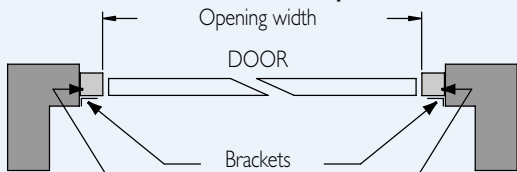

Single 68mm x 60mm [2 5/8" x 2 3/8"]  
Double 68mm x 75mm [2 5/8" x 3"]

Fitting to Quick-fit steel Retractable frame, behind the brickwork aperture

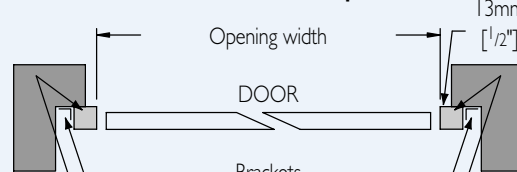

Single 68mm x 60mm [2 5/8" x 2 3/8"]  
Double 68mm x 75mm [2 5/8" x 3"]

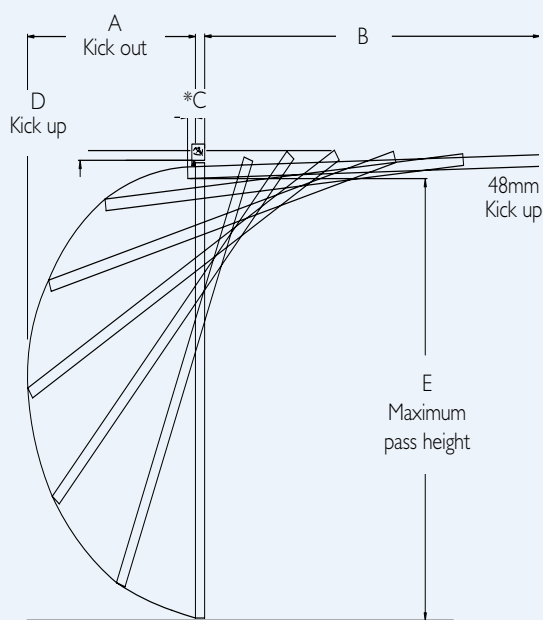

\*C = The amount that the door protrudes out from the back face of the frame with the door in the open position.

### KEY

	1981mm (6'6")	2134mm (7'0")
Size	high single	high single
Code	Lockfit Retractable	Lockfit Retractable
A	880mm	1030mm
B	1877mm	1877mm
*C	116mm	268mm
D	38.5mm	38.5mm
E	1884mm	2030mm

	1981mm (6'6")	2134mm (7'0")
Size	high double	high double
Code	Lockfit Retractable	Lockfit Retractable
A	900mm	1040mm
B	1877mm	1877mm
C	131mm	283mm
D	43mm	43mm
E	1890mm	2040mm

# TECHNICAL

## INSULATED ROLLER DOORS

### FITTING WITHIN THE APERTURE (Between walls or between reveal)

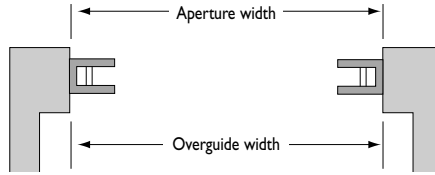
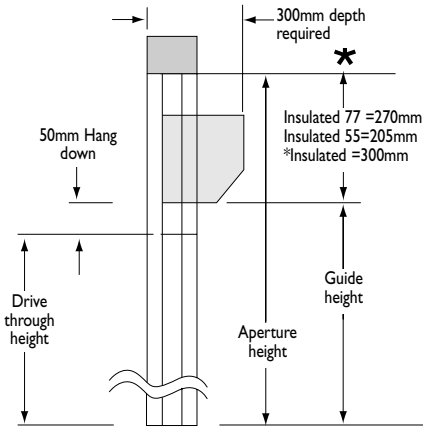

#### NOTES

For this type of installation we strongly recommend that a half box or full box is fitted, this will cover and protect the axle assembly and give added security.

### FIXING OPTIONS - Within the aperture

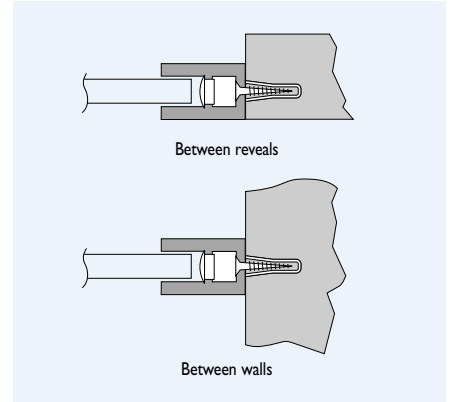

### FITTING BEHIND THE APERTURE

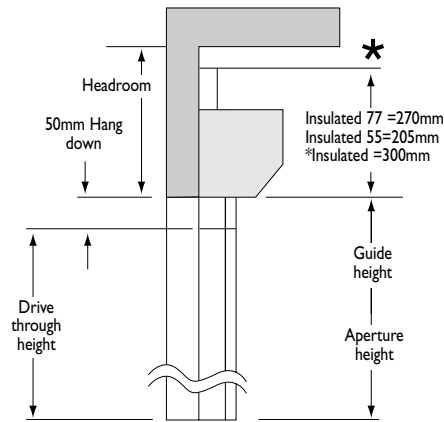

With headroom **GREATER** than  
Insulated 77 = 270/300mm or for Insulated 55 205mm

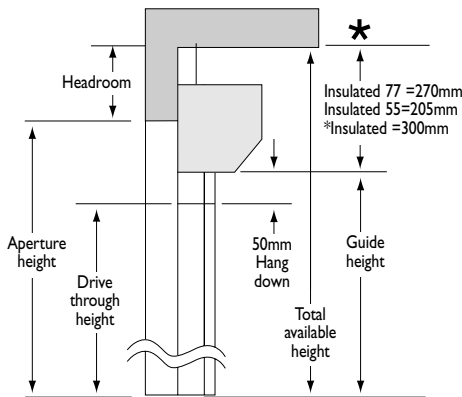

With headroom **LESS** than  
Insulated 77 = 270/300mm or for Insulated 55 205mm

### FIXING OPTIONS - Behind the aperture

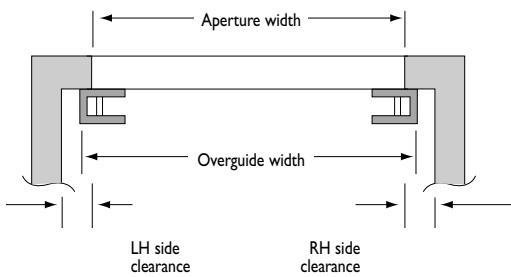
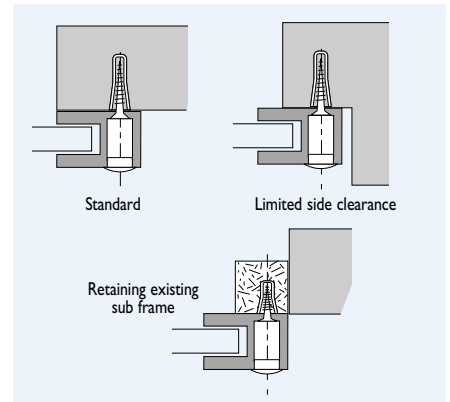

#### SIDE CLEARANCE

**Insulated 77:** 70mm or 95mm is required only if the guides are to be fully concealed. (70mm for door sizes up to 9sqm, 95mm for door sizes over 9sqm and guide heights above 2500mm and 66mm for all Insulated 55 doors). A minimum of 40mm is required to give sufficient room for fixing but a portion of the guide tracks will be visible.

#### HEADROOM

**Insulated 77:** 270mm for door sizes up to 9sqm 300mm for door sizes over 9sqm, over 2500mm guide height & any doors with a roll box option selected  
**Insulated 55:** 205mm for all doors

#### NOTES:

- Doors can be installed either within the garage opening or behind the garage opening (see illustrations above).
- If fitting the door drum within the garage opening, a full box must be used to cover the drum and the motor.
- When ordering a door, please use the dedicated order form and current price list.

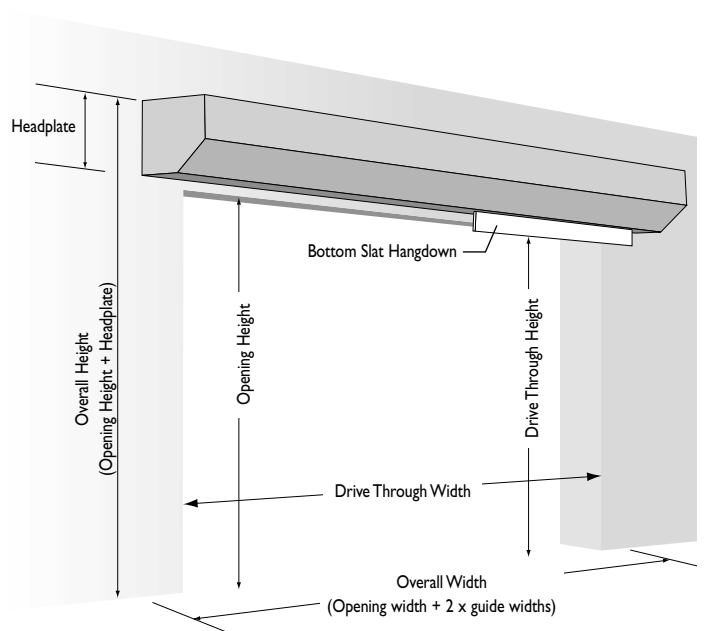

# TECHNICAL

## ROLLER DOORS

### STANDARD DOOR AND BRICKWORK APERTURE SIZES

- Steel roller doors are specified by curtain size and made to measure in 5 mm (3/16") increments from 900mm (3'0") wide x 1200 mm (4'0") high to 5100 mm (16' 9") wide x 3050 mm (10' 0") high.
- Widths up to 3404 mm (11' 2") are classed as 'A' series. Widths above this are classed as 'AA' series.
- When correctly installed the door curtain should overlap the opening width on both sides by a minimum of:
  - 25 mm each side for 'A' series doors without Rollguard
  - 50 mm each side for 'AA' series doors without Rollguard
  - 35 mm each side for all doors supplied with Rollguard

### HEADROOM

The minimum clearance between the bottom of the lintel and the ceiling will vary according to the door height required, as illustrated below.

### NOTES

- The clearance must extend back into the garage by 500 mm for all door heights.
- The stated headroom is only necessary if the door roll is to be hidden from outside view. In cases of reduced headroom, the roll can be fixed lower; however there will be a corresponding reduction in drivethrough height.
- The drive-through height will be a minimum of 80 mm less than the opening height.

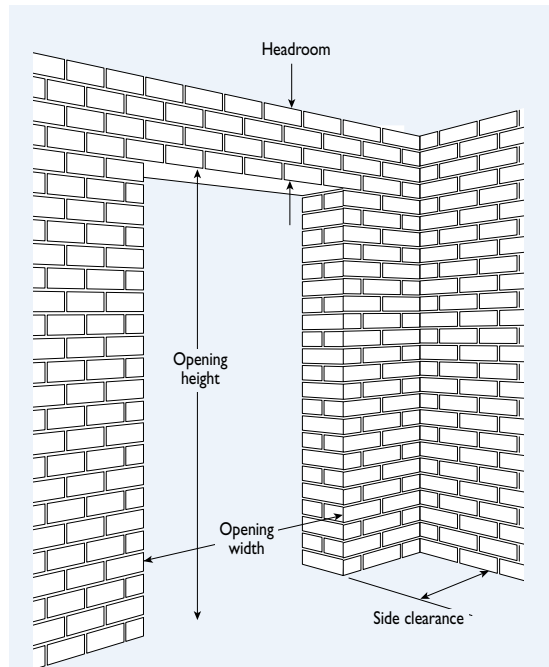

Minimum clearance required per side		
Door type	Manual door	Automatic door (Operator side only)
'A' Series	90mm	100mm
'AA' Series	120mm	150mm
All doors with Rollguard	150mm	150mm

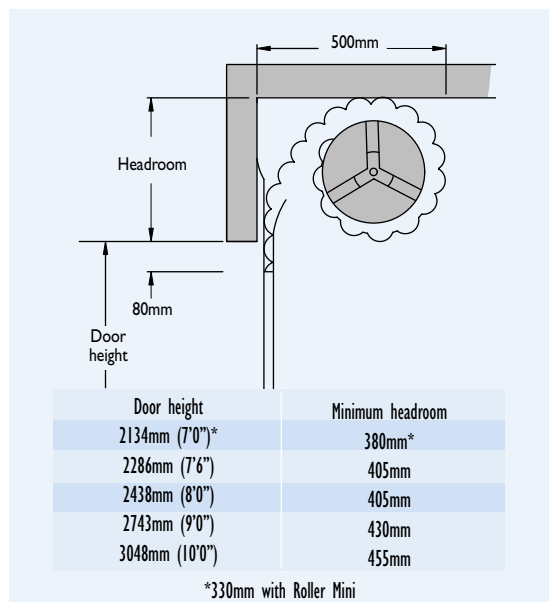

Henderson roller garage doors are designed to fit behind the brickwork opening and to overlap the brickwork slightly in width. To order the size of your Henderson roller door, follow these 3 steps:

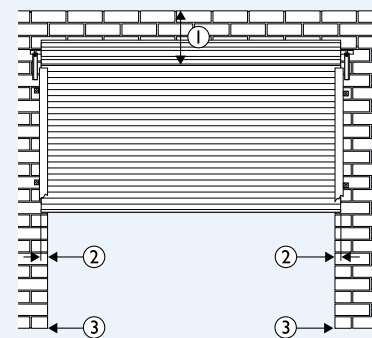

Series A = Doors to 3710mm wide  
Series AA = Doors over 3760mm wide

1. Check that there is sufficient space available for the minimum headroom requirement dependent on the height of the door; please see minimum headroom requirements table below. The clearance must extend back into the garage by 500mm for all door heights.
2. The door should overlap the opening on each side by: Series A:25mm, Series AA:50mm. Therefore to specify the opening width, state the opening +50mm (Series A) or opening +100mm (Series AA). State the height from inside floor to underside of the brickwork.
3. Check the minimum sideroom required between the opening and the side wall of the garage, this will be dependent on the door type and the method of operation, please see the minimum clearance per side table to the left.

### MINIMUM CLEARANCES

Aperture Width	Curtain width	
	Excluding Rollguard	Including Rollguard
1219mm (4'0")	1270mm	1290mm
1829mm (6'0")	1880mm	1900mm
2134mm (7'0")	2185mm	2205mm
2286mm (7'6")	2335mm	2355mm
2438mm (8'0")	2490mm	2510mm
2591mm (8'6")	2640mm	2660mm
2743mm (9'0")	2800mm	2820mm
3048mm (10'0")	3100mm	3120mm
3353mm (11'0")	3400mm	3420mm
3658mm (12'0")	3760mm	3730mm
4267mm (14'0")	4370mm	4340mm
5000mm (16'5")	5100mm	5070mm

These dimensions should be added to the aperture width when specifying to give the correct curtain width, as per the table above (note: curtain sizes have been rounded).

The curtain height should be specified the same as the aperture height.

# TECHNICAL

## SECTIONAL DOORS

### g60 SECTIONAL GARAGE DOORS

The Henderson g60 sectional door can be fitted either to a good quality timber frame or direct to sound brickwork and can be fitted either within or behind the brickwork opening. If fitted within the brickwork opening, the door must be fitted to a timber frame.

#### To fit a g60 door behind the brickwork opening

Measure the brickwork opening width (A) and height (B). Ensure you have adequate sideroom, headroom and clear space (depth) into the garage. The space required is determined by the operating gear chosen. See the table below for details of the operating gear options.

#### To fit a g60 door to a timber frame within the brickwork opening

Measure the brickwork opening width (A) and height (B). Subtract the required side and headroom (as shown below) and install a timber frame to suit. For example, a door with standard tension gear will require a timber frame of minimum nominal 3"x3" (70mm x 70mm) for the frame legs and 6"x 3" (150mm x 70mm) for the frame head.

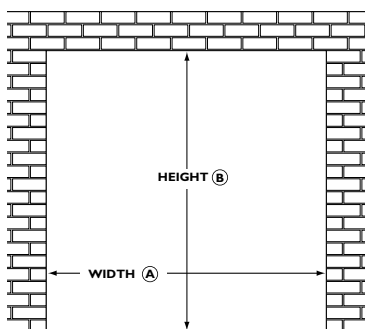

SIDEROOM/HEADROOM REQUIRED AND DEPTH OF TRAVEL INTO GARAGE					
Operating gear	Sideroom (mm)	Headroom (mm)		Depth into garage (mm)	
		Manual	Automatic	Manual*	Automatic
<b>Tension</b>	80	150	150	opening height (B) + 700mm	B ≤ 2250 = 3350 B ≥ 2375 = 4450
<b>Tension (low headroom)</b>	120	100	120	opening height (B) + 750mm	B ≤ 2250 = 3350 B ≥ 2375 = 4450
<b>Torsion front</b>	80	200	200	opening height (B) + 700mm	B ≤ 2250 = 3350 B ≥ 2375 = 4450
<b>Torsion rear (low headroom)</b>	80	100	120	opening height (B) + 800mm	B ≤ 2250 = 3350 B ≥ 2375 = 4450

\* when opening height is 1900mm, add on an extra 100mm

### g60 SECTIONAL DOORS

#### GEORGIAN DOOR - PANEL DETAILS

(H) PANEL HEIGHT	(DW) DAYLIGHT WIDTH mm	NUMBER OF EMBOSSES	A(J) END SPACING	(S) LAND SPACING	(X) EMBOSS HEIGHT	(G) EMBOSS WIDTH	(C) BOTTOM SPACING
See number of panels by door height	1800-2399	3					
	2400-3099	4	Min 71mm	Min 100mm	310mm	500mm	Min 91mm
	3100-3649	5	Max 231mm	Max 200mm			Max 151mm
	3650-4249	6					
	4250-5000	7					

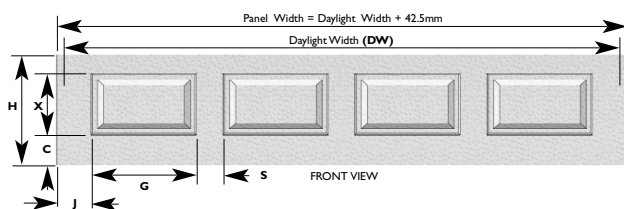

#### RIBBED DOOR - PANEL DETAILS

(H) PANEL HEIGHT	NUMBER OF RIBS	(X) RIBBED AREA	(Y) SPACE BETWEEN RIBS	(Z) RIB WIDTH	(C) BOTTOM SPACING
See number of panels by door height	6	300mm	58mm	9mm	Min 113mm Max 156mm

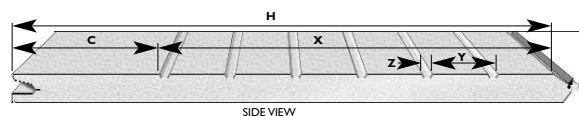

#### STYLE DOOR - PANEL DETAILS

(H) PANEL HEIGHT	NUMBER OF RIBS	(W) RIB WIDTH	(B) BOTTOM SPACING
See number of panels by door height	1	9mm	Min 216mm Max 259mm

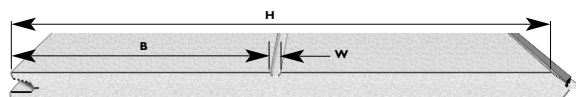

#### NUMBER OF PANELS BY DOOR HEIGHT

DOOR HEIGHT (mm)	NUMBER OF PANELS	PANEL HEIGHT (mm)
3000	6	483
2800	5	545
2650	5	514
2500	5	483
2375	5	458
2250	4	545
2125	4	514
2000	4	483
1900	4	458

# TECHNICAL

## SECTIONAL SIDE DOORS

### g60 SIDE ENTRANCE DOORS

DOOR CODE	ORDER SIZE (mm) WIDTH x HEIGHT	OUTSIDE FRAME SIZE (mm) WIDTH x HEIGHT	PASS THROUGH OPENING (mm) WIDTH x HEIGHT	BRICKWORK OPENING SIZE (mm) IF FITTED BEHIND THE OPENING - WIDTH x HEIGHT				BRICKWORK OPENING SIZE (mm) IF FITTED WITHIN THE OPENING
				INWARD OPENING DOOR		OUTWARD OPENING DOOR		
				MINIMUM	MAXIMUM	MINIMUM	MAXIMUM	
T2	1000 x 2000	1136 x 2068	941 x 1980	1000 x 2000 - 1090 x 2045		1046 x 2023 - 1126 x 2063		1156 x 2078
T3	875 x 2125	1011 x 2193	816 x 2105	875 x 2125 - 988 x 2170		921 x 2148 - 1006 x 2188		1031 x 2203
T4	875 x 2000	1011 x 2068	816 x 1980	875 x 2000 - 988 x 2045		921 x 2023 - 1006 x 2063		1031 x 2078
T5	1000 x 2125	1136 x 2193	941 x 2105	1000 x 2125 - 1090 x 2170		1046 x 2148 - 1126 x 2188		1156 x 2203

#### FITMENT BEHIND THE OPENING: OUTWARD OPENING DOOR

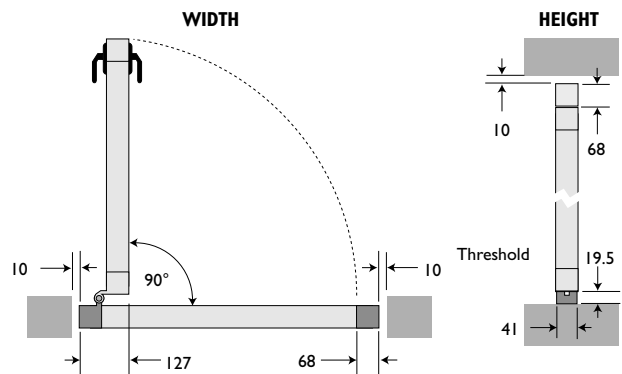
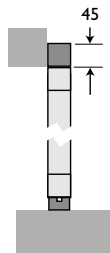
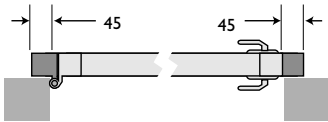

#### FITMENT BEHIND THE OPENING: INWARD OPENING DOOR

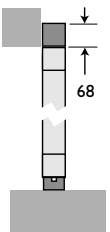
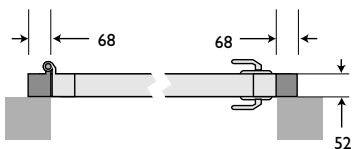

#### PASS THROUGH OPENING

WIDTH = OUTER FRAME SIZE - 195mm (127mm + 68mm)

HEIGHT = OUTER FRAME SIZE - 88mm (68mm + 19.5mm)

#### FRAME CLEARANCE RECOMMENDED

(FITTED WITHIN THE BRICKWORK OPENING)

WIDTH 20mm - HEIGHT 10mm

#### SIDE ENTRANCE DOOR SPECIFICATION

##### STYLES AVAILABLE

Georgian, Ribbed, and Trend in 42mm profile

##### FINISHES AVAILABLE

Two standard colours: White RAL 9016 and Brown RAL 8014 (brown chargeable) or in special paint according to RAL and NCS colour systems.

##### HANDLE

All doors supplied with a black aluminium handle eurocylinder lock as standard

##### OPENING/HANDING

Doors can be supplied opening to the left or to the right and to the inside or outside.

Please state handing as viewed from the outside.

- Inward opening door, handle on the left (hinges on the right) = left handed
- Outward opening door, handle on the left (hinges on the right) = right handed

#### FITMENT WITHIN THE OPENING:

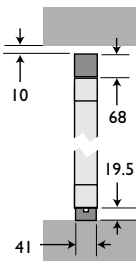
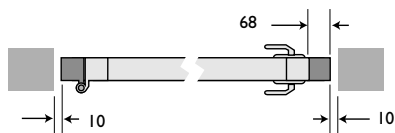

# TECHNICAL

## SIDE HINGED DOORS

Brickwork aperture sizes for frames fitted within the opening

Steel frame (50 x 40 mm)		
Size code	Door size	Steel aperture
	width x height	width x height
6666	1981 x 1981 mm	2087 x 2095 mm
6670	1981 x 2134 mm	2087 x 2177 mm
7066	2134 x 1981 mm	2240 x 2095 mm
7070	2134 x 2134 mm	2240 x 2177 mm
7666	2286 x 1981 mm	2392 x 2095 mm
7670	2286 x 2134 mm	2392 x 2177 mm
8066	2438 x 1981 mm	2544 x 2095 mm
8070	2438 x 2134 mm	2544 x 2177 mm

- Door sizes given are for opening sizes within the frame.
- Aperture sizes include a minimum 3 mm gap between the frame and the brickwork on all three sides to allow for coursing and tolerances.

### FITTING THE FRAMES TO THE BRICKWORK

Frames should be fitted within the brickwork as per the drawing shown below:

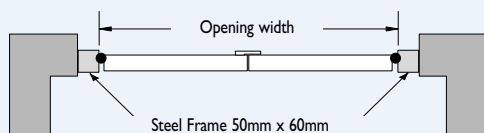

### OPENING ARC OF TRAVEL

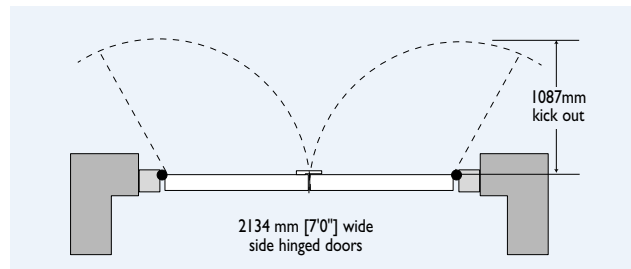

- Side hinged doors are supplied pre-framed as standard and come complete with a brass effect Euro profile night latch and deadlock, a pair of door stays, two monkey tail shoot bolts and four anti-drop anchored dog bolt hinges per door leaf.

### STANDARD CONFIGURATION

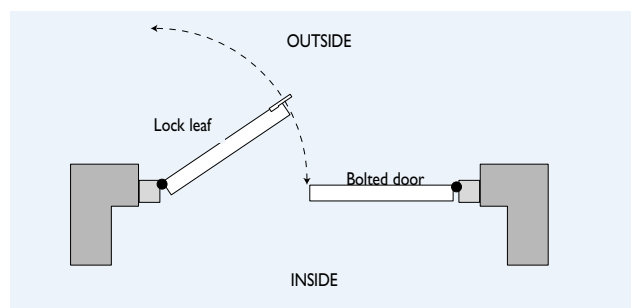

- Doors are supplied to open outwards with the lock on the right when viewed from the outside. Left hand opening is available as an option.

# GUARANTEES

- (a) Henderson garage doors are guaranteed against any form of manufacturing defect for a period of 2 years from the date of original purchase.
- (b) Henderson garage doors also guarantee that its garage doors will operate safely and reliably for a period of 10 years from original installation.
- (c) Henderson garage doors electric operators are guaranteed against any form of manufacturing defect for a period of 5 years for mechanical elements, motors and transformers and for a period of 2 years for other electronic and radio equipment.
- (d) The Exterior finish is guaranteed to provide an effective weatherproof membrane which will resist perforation of the substrate from the weather side due to corrosion for the periods indicated below.

**10 years** - Factory Fully Finished Doors: Steel, GRP & ABS Up & Over Doors, Roller Doors & Sectional Doors

**2 years** - Fully Finished Timber Doors, Security Shutters, Collapsible Security Gates, Security Bars and \*Primed Steel Doors

**1 year** - \*Basecoat Timber Doors

Colour change or fade to the exterior surface will be limited and uniform for a minimum period of 2 years. \*(subject to finishing in accordance with terms and conditions)

## Guarantees are subject to the condition as set out below;

1. During the comprehensive 2 year guarantee period BRP Group Limited companies undertake to repair or replace (at its discretion), and without charge, products or components which have suffered any form of manufacturing defect. Claims must be notified within 3 days from the date of delivery or within a reasonable time after discovery of any defect.
2. Products covered by these guarantees must have been purchased through an authorised BRP Group Limited Companies garage door supplier or as original equipment attached to a newly built dwelling.
3. The warranties shall apply for normal use only. Normal use constitutes no more than 5 operations (open/close cycles) per day.
4. The warranties offered attach to the BRP Group Limited Companies product only and no consequential damages will apply no matter how caused.
5. No liability will be accepted as a result of normal wear and tear, incorrect storage, incorrect handling, faulty installation, incorrect use or wilful damage.
6. Claims under this guarantee must be made through the original supplier and accompanied by relevant documentation indicating the date of purchase (e.g. receipt).
7. BRP Group Limited Companies maximum liability shall be the original purchase price inclusive of Value Added Tax at the rate prevailing when supplied.
8. Any product which is the subject of a claim:
  - i) must have been correctly installed in accordance with the installation instructions supplied and thereafter properly maintained by a suitably experienced engineer on a regular basis as set out in the Maintenance and Operating Instructions provided with every door. (Additional copies of these instructions are available by contacting the installer or the manufacturing company). We recommend that regular maintenance is provided by a suitably experienced engineer. See your Yellow Pages for your local BRP Group Limited Companies Garage Door specialist.
  - ii) must have the manufacturers reference number still intact (found on the barcode label on the door)
  - iii) must not have been modified in any way.
9. Claims will not be accepted where the cause is due to:
  - i) impact or mechanical damage suffered during or following installation, e.g scratches, indentations, tears, scuffs or other surface abrasion.
  - ii) damage or discolouration caused by contact with any form of caustic, abrasive or corrosive substance, fumes, bird droppings, fire, smoke, floodwater, salts, acids, or from exposure to abnormal atmospheric pollution.
10. This guarantee excludes normal wear and tear on items such as cones, cables, spindles, lock cylinders, hinges or springs.
11. Only BRP Group Limited Companies original spare parts must be used when required. The use of non-BRP Group Limited Companies parts shall invalidate this guarantee. Warranty period for replacement parts is 6 months or the balance of the original warranty period if greater.
12. The Exterior Finish Guarantee applies only to the weatherside surface and where more than 5% of the surface area of the door is affected. Surfaces must be freely exposed to washing by rainfall and kept clear of accumulated dirt and debris and given equal exposure to local environmental conditions and consistent natural lighting conditions across the face of the door. Special attention is drawn to Clause (9) (ii).

Marking may occur to either side of the a roller door or shutter curtain over time due to the rolling nature of operation. This does not affect the performance of the door and is not part of the guarantee.

13. Primed steel doors and basecoat treated timber doors must receive a suitable exterior quality finishing topcoat immediately after installation. This topcoat finish must be applied strictly in accordance with the manufacturer's instructions.
14. The guarantee period for electric operators excludes batteries, fuses and light bulbs.
15. Parts replaced free of charge become the property of BRP Group Limited Companies.
16. Attempted repairs by non-qualified individuals shall invalidate this guarantee.
17. The specific terms of this guarantee shall only apply to products purchased on or after August 2009 within the UK and Eire.
18. BRP Group Limited Companies garage doors and associated products are sold subject to the BRP Group Limited Companies Standard Terms and Conditions of Sale, copies of which are available upon request. BRP Group Limited Companies shall not be liable as a result of any representation, implied warranty or other term or condition or for any consequential loss or damage, costs, expenses or other claims whatsoever except as expressly set out in these Terms and Conditions of Sale.

## General Advice

**Door Cleaning.** Periodically clean the door panel using warm water and a soft cloth or sponge. Allow to dry naturally. Never use detergent, abrasive, caustic or solvent based cleaners as they may damage the door surface. Bird droppings should be removed immediately as these can be particularly caustic.

**Door Servicing and Maintenance.** All doors should be operated and maintained in line with operating and maintenance instructions supplied with every door. Every six months visually inspect all wear items (including cables) for signs of wear. If wear is detected we recommend you contact your local BRP Group Limited Companies supplier to arrange for a replacement. Garage door springs are under extreme tension and should only be repaired or replaced by a suitably qualified engineer.

Other performance issues affecting BRP Group Limited Companies. garage doors are:

BRP Group Limited Companies G.R.P. doors are individually handcrafted products manufactured to specific customer order. Due to the nature of the product and the hand finishing processes used they may occasionally display small blemishes which do not detract from the overall appearance of the product. These are regarded as being within manufacturers tolerance when such blemishes are not visible to the naked eye when viewed from a distance of three metres. Similarly, Woodgrain effect products will, like the natural material, display colour variations across their surface and colour will vary from door to door. Ordering doors to match helps reduce the variation but will not eradicate it entirely.

Translucency of the G.R.P. door panel may vary when viewed from the inside on a bright day due to variations in laminate thickness. This does not represent a manufacturing defect and overall performance is not affected.

G.R.P. Size and Deflection - the natural curing process does not affect the ultimate product size and a tolerance of  $\pm 6$ mm on both height and width is deemed acceptable. Up and over doors in the 'open' position will display a level of vertical deflection or 'sag' across the width of the panel and up to 6mm per linear metre is within design tolerance.

BRP Group Limited Companies Timber doors are made from the finest timber obtained from managed and sustainable sources. Prior to fitting they must not be stored in direct sunlight or exposed to splashes or rain as colour fading and/or staining may result. The BRP Group Limited Companies product guarantee does not cover natural variations in colour, warping, swelling or shrinkage due to the ordinary natural processes of ageing, fading or the effects of weather or climate nor does it cover the incidence of similar degradation which could have been prevented by carrying out finishing and maintenance procedures as recommended by BRP Group Limited Companies. Doors that are not factory finished should be finished with a microporous stain, front and back, in accordance with the stain manufacturers instructions immediately after fitting.

BRP Group Limited Companies Steel doors are manufactured using high quality galvanised steel. A suitable exterior grade of paint should be applied as a finishing coat to primed doors in accordance with the paint manufacturers instructions.

Garage doors should be inspected upon delivery and viewed in natural daylight (not direct sunlight) from a standard distance of 3 metres to view their overall appearance. From this distance the door panel should appear free from visible marks or distortion, stains, blemishes, indentations or scuffs. If any marks are only visible within 3 metres they will not be considered under warranty.

These terms and conditions do not affect your statutory rights.

# ORDERING NOTES

## GENERAL

**Sizing:** Sizes shown for one-piece up and over doors refer to inner frame dimensions. To measure for a garage door, use the inner frame dimension - do not measure the existing door. Sizes shown for roller doors refer to the door curtain. Always ensure the curtain overlaps the opening by the recommended amount. Sizes for insulated roller doors refer to the over guide sizes (guide height and over guide width). Sizes shown for g60 sectional doors refer to the 'daylight opening' to the garage.

**Operating gear:** Henderson one-piece garage doors are available with a choice of canopy or tracked operating gear. The choice of operating gear determines the position of the door handle. On doors with canopy gear, the handle is located approximately one third down from the top edge of the door. On doors with tracked operating gear the handle is approximately one third up from the bottom edge. All tracked doors over 7'6" (2286mm) high incorporate heavy duty operating gear. If you wish to add a remote control system to your door, we recommend you order a door with tracked operating gear. We recommend that all doors over 7'6" high should use a Henderson remote control system. Be aware that in certain circumstances, the use of garage doors at either end of a garage can create a 'wind tunnel' which can place undue stress on the operating gear. It is your responsibility to ensure there is sufficient sideroom, headroom and free depth space in the garage to install the door and operate it safely.

**Standard Security:** All Henderson doors are fitted with two point sprung action locking as standard. Roller doors are supplied with dual locking bars. g60 sectional doors are available with security latch locking as an option. Insulated roller doors are always automated for security.

**Frames:** One-piece up and over garage doors are available with a metal frame. The frame supplied with Premiere Steel and Timber doors is 76mm box section steel as standard. A narrow fit 60mm box section frame is available for single sized up and over doors (up to 2743mm wide) on request. The frame supplied with GRP doors is 68mm jamb as standard. A narrow fit 54mm jamb frame for single doors is available for canopy operating gear only.

**g60 Side Doors:** Side doors can be supplied for opening to the left or right and to the inside or outside. Please state handing as viewed from the outside. ● Inward opening door, handle on the left (hinges on the right) = left handed. ● Outward opening door, handle on the left (hinges on the right) = right handed. All doors are supplied with a black aluminium handle and eurocylinder lock as standard. g60 side doors are available in White (RAL 9016) or in Brown (RAL 8014) or to a RAL specification. The inside of the door is always white. The panel thickness is 42mm.

## ONE PIECE DOOR FINISHES

**Premiere steel doors** are supplied with a factory applied all over matt white primer coat to allow the homeowner to apply a finishing coat to complement the colour scheme of their home. Factory applied all over deep textured fully finished white and deep textured fully finished coloured doors are available as options. Selected door styles are also available in a fully finished Plastisol or laminated steel to the exterior surface as an option. The glazing cassettes on Warkworth and Bamburgh doors feature mock black windows. For added security, the cassettes have steel behind them and cannot be seen through.

**Timber doors** are supplied factory treated with a microporous water repellent sealant as standard and require finishing by the homeowner to provide complete protection and to complement the colour scheme of their home, with the exception of the Monarch door which is supplied in a Mahogany finish as standard. A factory applied Mahogany woodstain finish and a Dark Oak finish are available for the door styles indicated in the Timber door section. Please note that these finishes are hand applied and will raise the timber grain slightly when dry.

**GRP doors** are supplied factory fully finished in a choice of timber effect colours except the Consort, President and Solstice which are supplied in smooth gloss white.

# DELIVERY CHARGES

GARAGE DOORS			REMOTE CONTROL SYSTEMS/REPLACEMENT PARTS		
	AREA A The whole of England, Scotland and Wales, but excluding Areas in 'B'	AREA B Highlands, Scottish Isles, Isle of Wight, Channel Islands, Northern Ireland	Order Value (Nett)	AREA A Charge (Nett)	AREA B
1 Door	£45	On Application	£300 or More	Delivery Free	On Application
2 Doors	£37.50		Up to £300	5% Minimum Delivery Charge £4	On Application
3 Doors +	Free of charge				
Delivery to private residential address - on application.			Delivery charges will be calculated at receipt of order based on the delivery time-scale required and product weight. Minimum overnight carrier charge £15. Carriage charge will be applied to all orders when overnight delivery is requested.		

**ALL PREVIOUS PRICES WITHDRAWN. All prices shown exclude VAT.**

### HENDERSON PRODUCT POLICY

As our policy is one of continual product development, we reserve the right to introduce improvements to designs, changes to specifications and prices without notice.

### STANDARD TERMS

**Henderson Garage Doors standard terms and conditions of sale apply to all sales - a copy of these can be obtained by contacting the Customer Services.**