

// NEW: with 5-fold automatic lock as standard

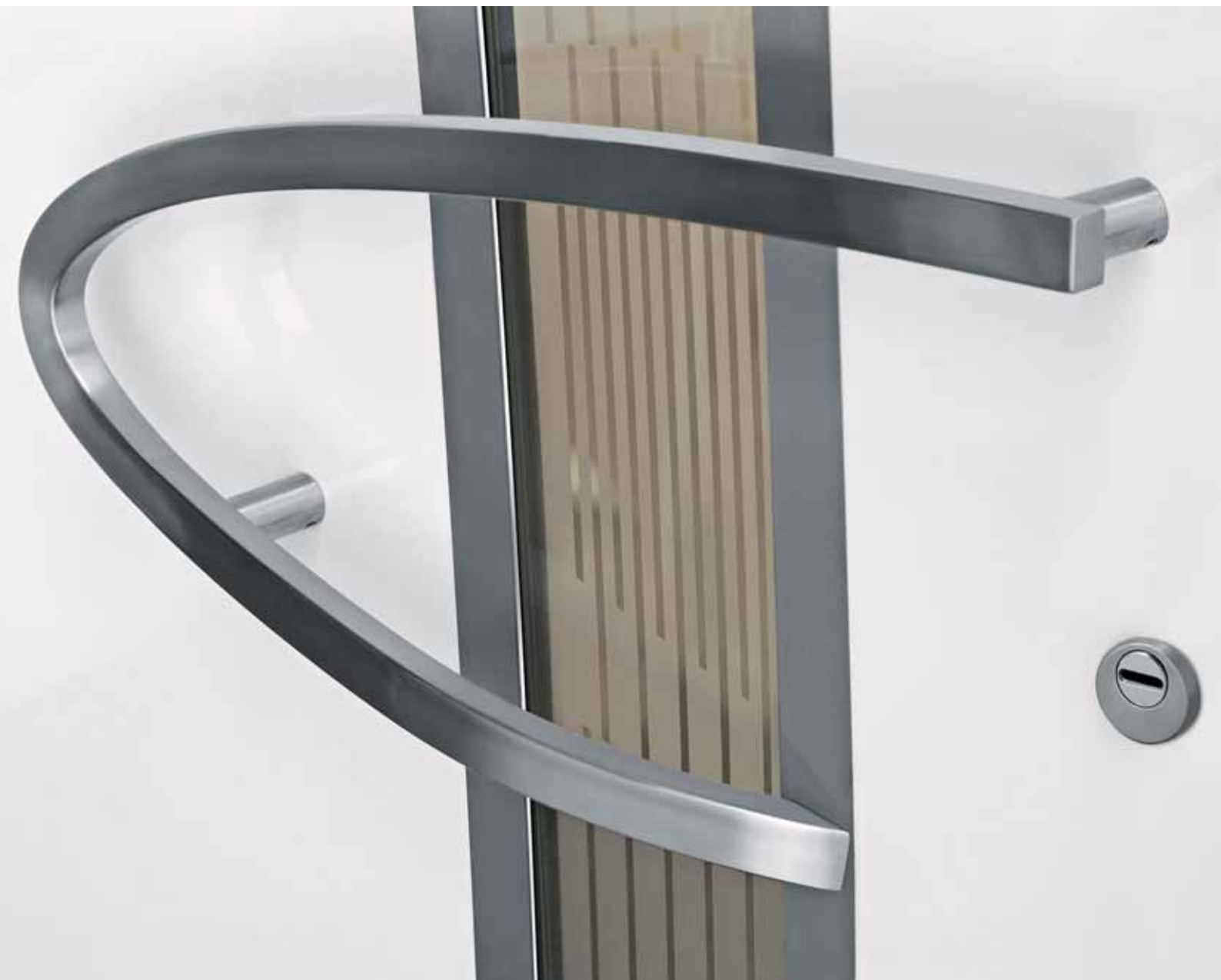

Aluminium Entrance Doors

Enjoy Comfort and Security for Your Home





Hörmann entrance doors for your home

Your new entrance door should be very special. It should match the style of your home and be prestigious, expressing your excellent taste. At the same time, your entrance door should also meet high security standards and help save energy with high thermal insulation values.

Aluminium doors are a good choice

You will soon notice that aluminium doors are superior to plastic and wooden doors in many ways. Other than the many technical equipment and design options, you can enjoy a number of additional advantages:

- high acoustic rating
- high thermal insulation
- high security
- high stability
- no follow-up painting necessary, the doors look as good as new after many years of service.

In addition, Hörmann offers you alternative entrance door programmes:

ThermoPro doors

The beautifully designed Hörmann ThermoPro doors made of aluminium and steel offer you high security and good thermal insulation at an affordable price.



For more information on aluminium entrance doors and other Hörmann quality products, visit: www.hoermann.com.

The colours shown are subject to the limitations of the printing process and cannot be regarded as binding.

All rights reserved. Reprinting, even in excerpts, requires our express approval. Subject to changes.

Enjoy quality from a single source – without compromises



Made in Germany

All entrance door components are developed and produced in-house at Hörmann. Our highly qualified employees permanently work on new products, continuous developments and improved details. The results are patents and one-of-a-kind products you can depend on. Endurance tests under real conditions ensure mature series products in Hörmann quality.

Certified brand quality

CE mark according to EN 14351-1

The CE mark confirms compliance with and observance of the principal requirements of the EC directives according to EN 14351-1 for all of our entrance doors.

Quality assurance system according to DIN ISO 9001

Hörmann's entrance door production is DIN ISO 9001 certified. One more example of the Hörmann Motto: "Quality without compromise".

Long-lasting. Guaranteed.

We are convinced of our products and our uncompromised quality assurance. That is why we issue a 5-year guarantee* on all Hörmann entrance doors.



* Extensive guarantee conditions are available at www.hoermann.com

TopComfort



The inexpensive basic version

TopComfort doors offer you equal degrees of design and functionality – the all round profiles are precisely connected and mitred at the edges, creating a harmonic frame around the styled infill, which is precisely framed by the leaf profile (1). The view of the interior shows the door infill with rounded beads and the trim with a discreet grey seal (2).

Good thermal insulation

The 80 mm thick profile system with thermal break and the 30 mm thick infill ensure good thermal insulation. Depending on the style, we offer you TopComfort entrance doors with a k-value of up to 1.4 W/m² K. This allows you to save heating costs and enjoy a comfortable atmosphere at home.

Double thermal insulation glazing

Even with entrance door styles featuring large glazed areas you do not have to fear excessive energy loss. This is because the thermal insulation glazing offers you a compelling k value of up to 1.1 W/m² K.

Optimally adjusted

The beautifully designed three-way hinges allow the TopComfort entrance door to be variably adjusted. This way, your entrance door is optimally sealed and falls smoothly and securely into its lock.



TopComfort three-way adjustable hinges

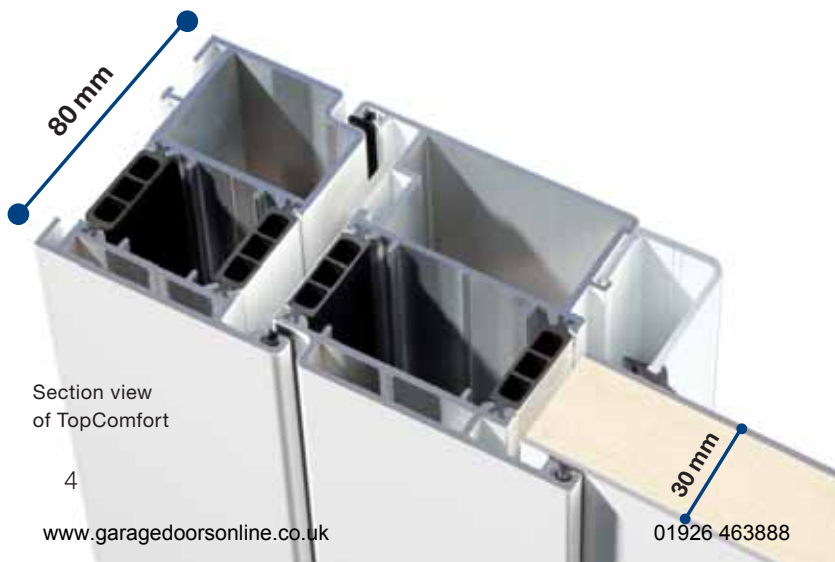

TopPrestige



The elegant overlapping-leaf version

In the TopPrestige version, the infill design is mounted onto the leaf profile, thus appearing generous and elegant when viewed from the outside (1). Inside, it has a pleasing slim leaf profile without strips and without a visible seal (2).

High thermal insulation

The glued composite structure of leaf and style infill of the TopPrestige versions offers you an entrance door with very high thermal insulation. Its thermal break profile system and the PU-foamed infill ensure that barely any heat escapes to the outside. Depending on the style, we offer you TopPrestige entrance doors with a k-value of up to 1.3 W/m² K.

Double thermal insulation glazing

For TopPrestige entrance doors with large glazing areas you receive a version with top thermal insulation values. They give you the benefit of thermal insulation glazing as standard with a k-value of up to 1.1 W/m² K.

Created for comfort

The beautifully designed three-way hinges allow the TopPrestige entrance door to be variably adjusted. You can always rely on your entrance door being optimally sealed and falling smoothly and securely into its lock.



TopPrestige with three-way adjustable hinges

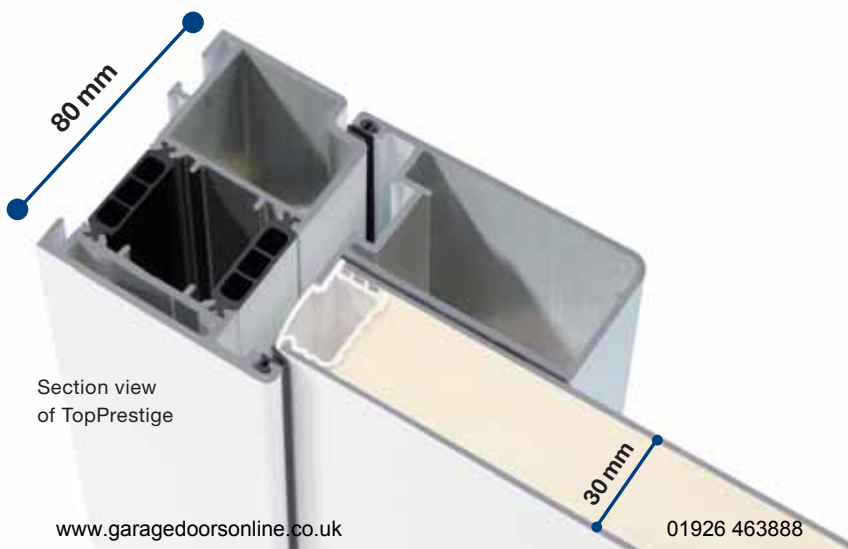

The Premium entrance door: Highest degree of thermal insulation and design



Exterior view

Viewed from the inside

TopPrestigePlus

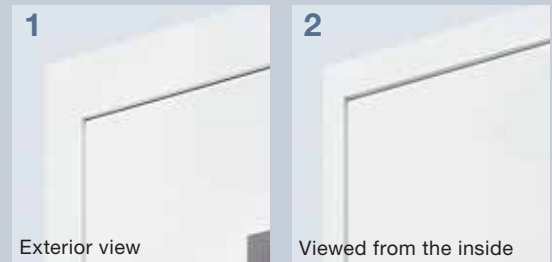

Added thermal insulation and design

With the TopPrestigePlus entrance doors, you can enjoy the highest degrees of comfort. This is because TopPrestigePlus versions are distinguished on the outside (1) and the inside (2) by infills overlapping the leaf. The flush-fitting interior view of the door harmoniously matches the doors of your home.

Use the thermal insulation that sets benchmarks

TopPrestigePlus entrance doors feature an 80 mm thick profile system with thermal break and a 70 mm thick insulated styled infill. With thermal insulation values of up to 1.0 W/m² K, they are especially suited for fitting into low-energy houses as well as houses with energy consumption values of KfW 40 to KfW 60.

For your additional comfort: triple thermal insulation glazing

Enjoy the triple glazing with a k-value of up to 0.7 W/m²K. The resulting minimum thermal loss translates into true energy and financial savings for you.

Functional elegance: Guide rollers

Our standard guide rollers offer you optimal comfort with an understated functional look. Their design guarantees simple and convenient adjustment of the door leaf, allowing you to comfortably and securely close your new entrance door at any time.



Elegant guide rollers for TopPrestigePlus

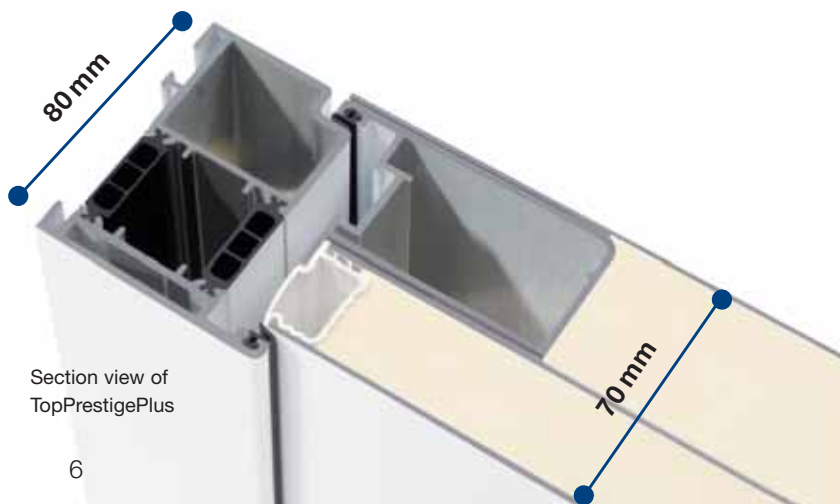

Section view of TopPrestigePlus

The look: fascinating

Rounded fascia frame, optional for all entrance door styles

For a particularly balanced look, we optionally offer you all entrance door styles with a rounded fascia frame as an additional outdoor design element. This stylishly enhances your entrance door, giving it a particularly harmonious look with rounded edges. Fascia frames are delivered as standard with Golden Oak versions.



For a harmonious look and a design element at the same time – included as standard for all entrance doors with Golden Oak surface.

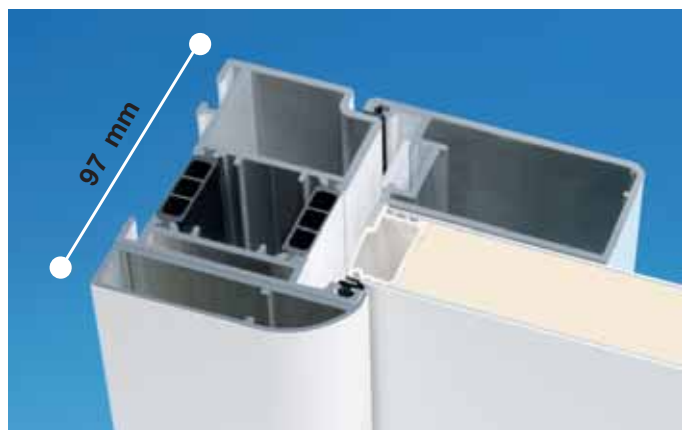

The additional fascia frame extends the depth of the frame profile to 97 mm.

"A good reputation must be earned."

August Hörmann, company founder, 1886–1944



Discover your new entrance door

And a programme that has much to offer

Choose according to your own wishes from 3 different versions to receive an individual look and thermal insulation: The inexpensive basic version TopComfort, the elegant leaf-overlapping version TopPrestige, or the TopPrestigePlus version with additional thermal insulation and design. No matter which version you choose – you will always receive top quality "Made in Germany".

Hörmann entrance doors for your home



40 TP



40 TP



40-8 TP

40-9 TP



40-9 TP

40-8 TP



41 TP

41 TC



45 TP

45 TC



45-5 TP



45-5 TP



62 TP

62 TC



65 TP



65 TP

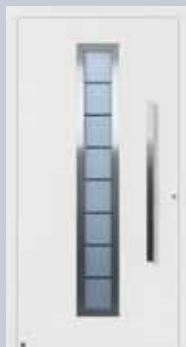

65 TP

65 TC





The Hörmann Design Programme

Garage door and entrance door with a matching look

This is how harmonious your home can look: The garage door and the entrance door are perfectly matched and are very attractive with their exclusive stainless steel and glass elements. The result is a thoroughly styled look for the most discriminating taste. This is the Hörmann Design Programme.

Hörmann entrance doors for your home

An exemplary beautiful combination: Garage door and entrance door



Sectional garage door style 457



Entrance door style 188 TP



Sectional garage door style 450



Entrance door style 693 TP

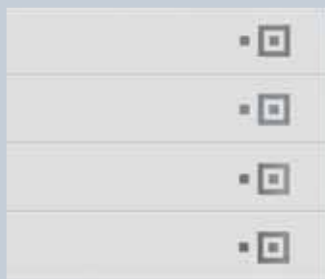

Sectional garage door style 453



Entrance door style 170 TP

The comprehensive Hörmann sectional garage door brochure contains all details of the Hörmann Design Programme.

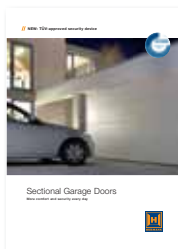

65-8 TP
65-9 TP



65-9 TP
65-8 TP



75 TP
75 TC



100



101



110 TP
110 TC



136 TP
136 TC



140 TP
140 TC

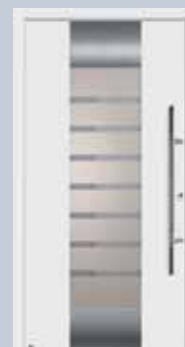

166 TP
166 TC



170 TP
170 TC



173 TP
173 TC



174 TP
174 TC

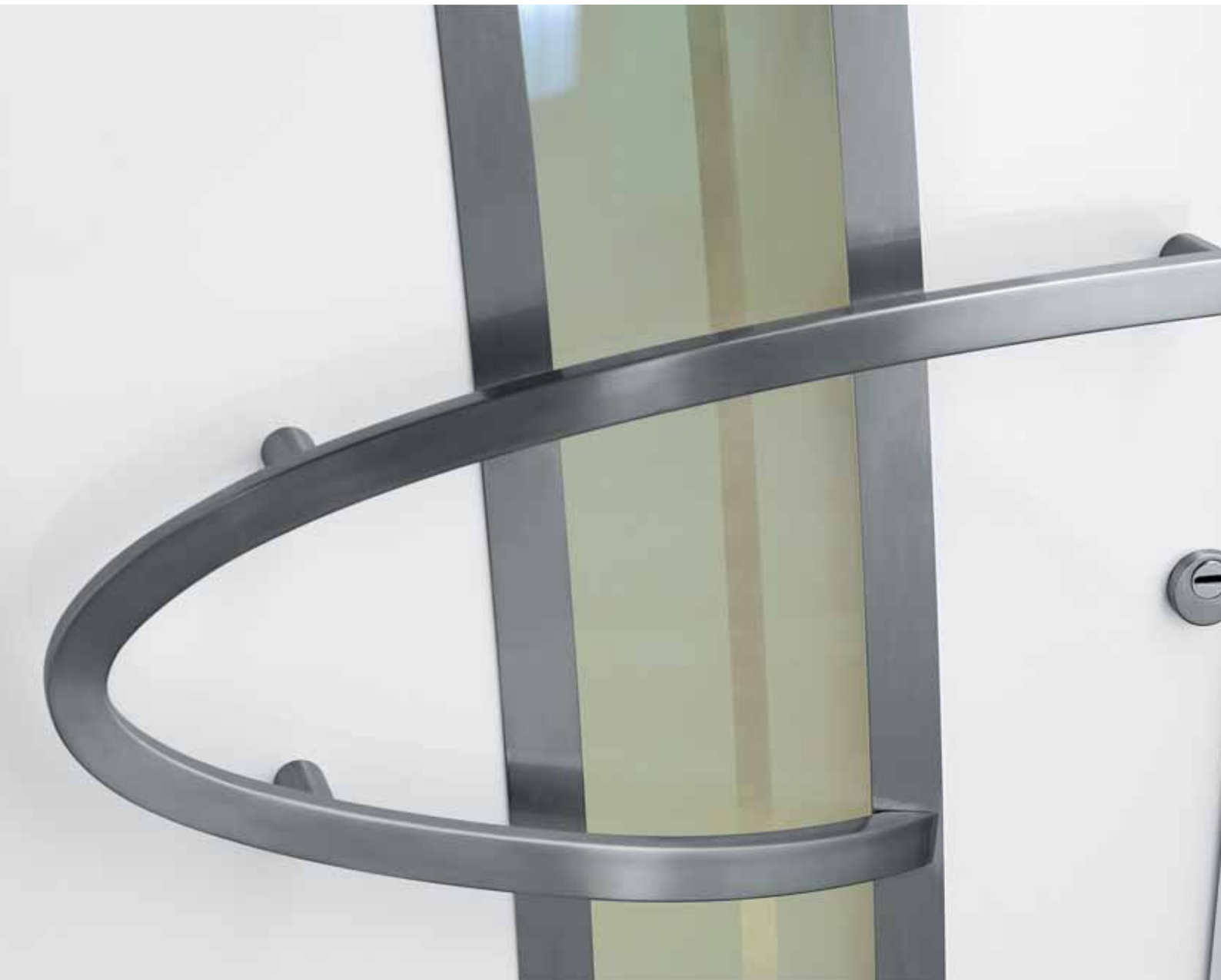

Entrance door styles that swing

Designed for discerning tastes

Don't choose just any entrance door – choose one that is perfectly suited to you and your demands. Hörmann offers you a large choice of exclusive styles with special designs that are not available anywhere else. The exclusive and elegant handles perfectly round off the appearance of these models.



177 TP
177 TC



185 TP
185 TC



188 TP
188 TC



402 TP
402 TC



413 TP
413 TC



449 TP
449 TC



551 TP
551 TC



551 TP



552 TP



552 TP



553 TP



553 TP
553 TC



554 TP



554 TP



555 TP
555 TC



The exclusive Hörmann colour shade CH 703

This colour with a structured surface in anthracite has a noble look. The Hörmann colour CH 703 is distinguished by its contemporary understated style. It provides a very special touch that is suited for special architectural styles.



At the focus of your attention

Matching entrance doors and garage doors

We think like you in terms of design. This is why we offer you the elegant lines of the ribbed look – a Hörmann garage door classic for many decades – also matched to the design of the Hörmann entrance doors. A visual accent that effectively highlights the stylish overall appearance of your home.

3 entrance door styles matching the Hörmann sectional garage doors with M and L-ribbing.



Discover single-concept design

The large, optimally matched Hörmann programme offers you ribbing for the garage and entrance door of your home in a harmonious single-concept style, i.e. based on a basic line without a visual offset. You will notice that it is these small but crucial details that reflect the beauty of your home.



TopPrestige entrance doors:
Style 875 TP
Style 895 TP
Style 898 TP

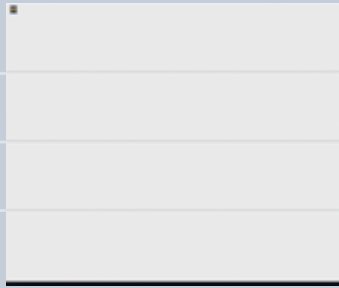

Sectional garage doors with L-ribbing:
with a door height of 2000 mm
with a door height of 2125 mm
with a door height of 2250 mm



TopPrestige entrance doors:
Style 825 TP
Style 845 TP
Style 855 TP

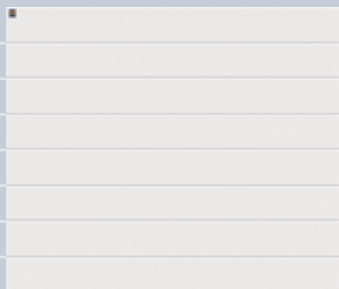

Sectional garage doors with M-ribbing:
with a door height of 2000 mm
with a door height of 2125 mm
with a door height of 2250 mm



With over 50 years of experience and 13 million doors sold, Hörmann has become number 1 in Europe for garage doors. Hörmann's automatic sectional doors feature modern convenience, high security, and a sophisticated appearance. Your Hörmann partner would be pleased to advise you further.

Hörmann entrance doors for your home



555 TP



556 TP
556 TC



556 TP



557 TP
557 TC



557 TP



558 TP
558 TC



558 TP



559 TP
559 TC



559 TP



560 TP



560 TP
560 TC



561 TP



Quick and clean within a single day

Professional and competent entrance door modernisation

The modernisation of your new entrance door is easier than you would expect. This is because your Hörmann partner offers you all-round competent service. Starting from consultation via measurement up to the fitting, including the disposal of the old door. Faster than you would expect, your home receives a new look. A decision that is sure to please you for a long time.

**Out with the old door,
in with the new:
fast and clean on the
same day.**



The renovation of an entrance door is a routine task for Hörmann professionals, which they can handle quickly and clean on a single day. The measurement at your home and the selection of the new door is soon followed by the modernisation process. Step 1: Your old door is professionally and cleanly dismantled and disposed of in an environmentally-friendly manner.



Step 2: The new Hörmann entrance door is fitted by the authorised Hörmann partner according to the measurements. The special entrance door threshold neatly covers up the transition from the interior to the exterior. The doors are fixed to the ground by concealed screws.



Step 3: The Hörmann fitter precisely adjusts the entrance door during the fitting, ensuring that your door will give you pleasure for a long time. This guarantees the optimal functioning of the Hörmann entrance door right from the start.

Hörmann entrance doors for your home



561 TP



562 TP
562 TC



562 TP



650 TP



650 TP
650 TC



650-8 TP
650-9 TP



650-9 TP
650-8 TP



659 TP
659 TC



667 TP
667 TC



667-5 TP



675 TP
675 TC



680 TP



An exclusive handle

Precisely matched to the door style

We have equipped every Hörmann entrance door with a high quality exterior handle matched to the respective style. This best highlights the design of each style. Of course, with the Vario programme you can also select a different handle according your individual preferences. Your specialised Hörmann dealer will provide you with prices and delivery times. For a detailed overview of the handles see pages 26 and 27.

Hörmann entrance doors for your home

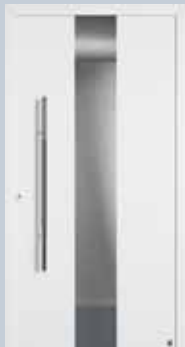

680 TP
680 TC



680-8 TP
680-9 TP



680-9 TP
680-8 TP



686 TP
686 TC

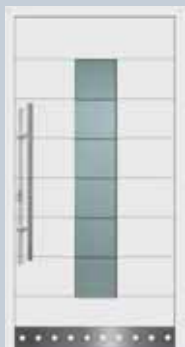

689 TP
689 TC



693 TP
693 TC



694 TP
694 TC



694 TP

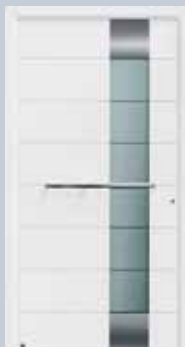

697 TP
697 TC



697-5 TP



700 TP
700 TC



860 TP
860 TC

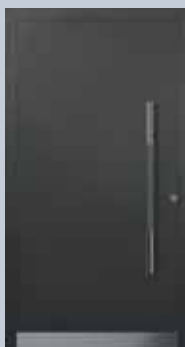

860 TP



861 TP



861 TP
861 TC



866 TP
866 TC



More light, more style

Express your taste with this style's attractive sand-blasted fluted glass design. You will also enjoy more light in your home.



This is security you can count on

Our entrance doors offer you 6-fold high protection

When it comes to security, you can also rely on the high quality of Hörmann doors – the H-5-Automatic special security pivoting bolt lock included as standard provides your home with quality-tested protection. When locking, 3 steel bolts with 2 additional hooks pivot into the stainless steel lock plates. In addition, a stainless steel bolt on the hinge side engages with the fascia frame. This way, you can feel perfectly secure with the effective 6-point locking system.

// NEW: Standard 5-point automatic lock

When locking, 3 steel hooks with 2 additional bolts (on top and on bottom) pivot into the stainless steel lock plates to automatically lock the door. If required, this function can be disabled for the use of the optional electric opener.



Variably adjustable:
Electric opener (optional)
The electric door opener catch in the lock plate ensures that your guests can only enter your home if you push the electric door opener inside. Alternately, during daytime you can also toggle the locking lever so that the entrance door can be opened by a slight push from the outside.



Solid security bolt
A stainless steel bolt engages during locking with the fascia frame. This way, it protects the door on the hinge side from being excavated or pushed in.

Standard equipment



Beautifully designed interior lever
Standard in stove-enamelled white or optionally in stainless steel or RAL to choose.



Beautifully shaped security rose escutcheon
This additionally protects the profile cylinder from being drilled open and twisted off. Available in white RAL 9016 as standard and in stainless steel for Golden Oak and anthracite surfaces.



Threshold with thermal break
Extremely robust, 80 mm thick and offering thermal insulation – the entrance door threshold with thermal break and concealed bolting to the bottom. In EV1 silver coloured.

HINT: The S-5-Automatic/comfort locks are VDS (German Property Insurance Association)-tested and certified. This means that the self-locking doors are considered locked in case of a break-in, maintaining your claims towards your property insurance.



Securing excellent properties!

Highest protection matched with convenient operation

Always, good to know – beyond the standard security equipment of Hörmann entrance doors, you can equip your door with intelligent technology for more comfort and security. Hörmann offers you for this the latest options. Your Hörmann partner will offer you consultation and information on this topic.

For all Comfort versions you can continue to unlock your entrance door with its key.

Graduated higher security

Hörmann offers you various security packages offering graduated additional security and comfort.



Secure opening with an integrated steel bar:

The **S-3 S** security package features a steel bar integrated in the lock. This allows you to initially open the door only a crack, preventing strangers from pushing it open all the way. This security package is also available with an automatic lock (**S-5 S Automatik**) which automatically locks your entrance door when it is pulled shut. The automatic lock is also available without a steel bar (**S-5 Automatik**).

Automatic locking – comfortable opening:

The **S-5 Comfort** security packages feature an automatic lock that locks the door automatically when pulled shut. When opening via one of the control element options (internal push button, hand transmitter, etc.) an integrated motor releases the lock and the door can be easily opened. Of course you can continue to unlock your entrance door with its key.

Push button opening

With **S-5 Comfort**, your entrance door can be opened at the push of a button from the inside, e.g. via the house intercom. This is especially suited for multi-party residences.

Via finger print: (see image on left):

S-5 Comfort Scan opens your door with a finger scanner. You and your family no longer need keys. Incidentally, you can also equip your Hörmann garage door with this technology.



With transponder technology:

With **S-5 Comfort Plus**, you can additionally open your door very conveniently from the outside via transponder technology, i.e. with an electronic key without having to touch the door.



The Vario programme

Tailored to your wishes

The Hörmann Vario programme has almost no limits. You can choose from a large range of options and decide individually what your entrance area should look like. You decide on the colour of your Hörmann entrance door, its handle and its glazing. Your Hörmann specialised dealer will gladly provide you with delivery times and prices.

Individual choice of colours or timber design

In addition to our standard colour RAL 9016 white, you can also receive all other RAL colours according to your wishes.



402 TP in sepia brown RAL 8014.



667 TP in window grey RAL 7040.



694 TP in moss green RAL 6005.



40 TP in wine red RAL 3005.



185 TP in grey olive RAL 6006.



45 TP in black brown RAL 8022.

A handle on everything – with a design according to your wishes

In this catalogue we have already chosen from the multitude of possibilities a matching handle for the style of each entrance door shown. Yet this is only a suggestion. You can select your personal favourite from our programme according to your wishes and conceptions. Because your taste is what matters. Following is an overview of all available handles. (Delivery times and prices may vary). Your specialised Hörmann dealer will provide you with prices and delivery times.



61-1
Long escutcheon security handle, aluminium



61-4
Long escutcheon security handle, white



62-1
Long escutcheon security handle with exterior knob, aluminium



62-4
Long escutcheon security handle with exterior knob, white



38-1
Stainless steel with decorative centre piece

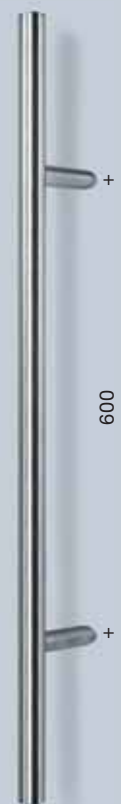

38-2
Brushed matt stainless steel



21-1
White plastic



21-2
Black plastic



91-2
Brushed stainless steel



92-2
Brushed matt stainless steel



26-1
White aluminium



26-2
Brown aluminium (or RAL to choose)



27-1
White plastic
27-2 Black plastic



94-2
Brushed matt stainless steel



14-1
Stainless steel with decorative centre piece



14-2
Brushed matt stainless steel

+ mm + = axis dimension

