

SPARE PARTS CATALOGUE

SECTIONAL &
UP & OVER DOORS

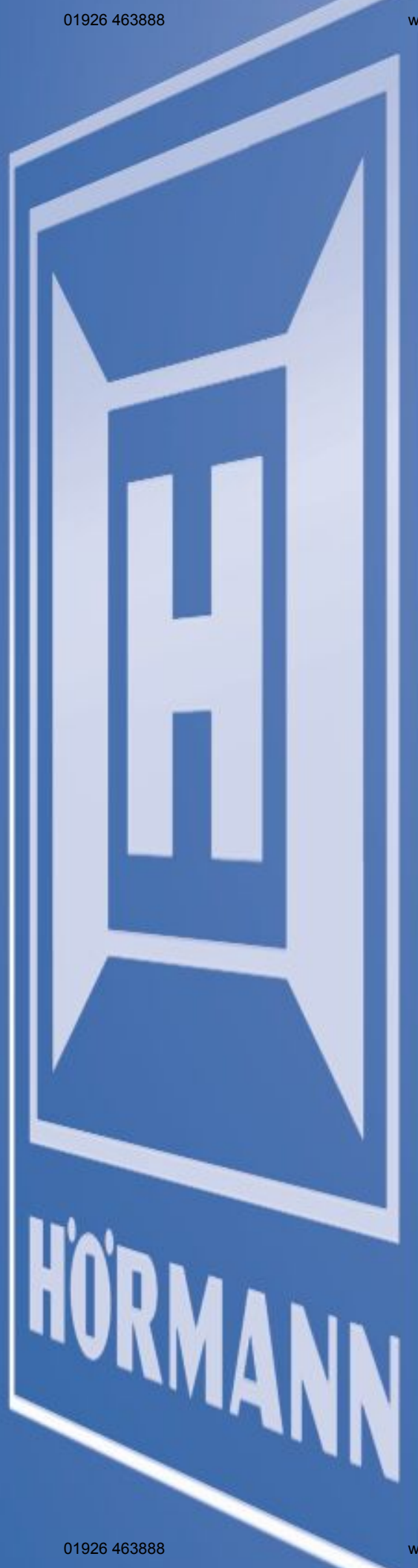

MARCH
2011



This parts list shows all common parts for our series 2000 sectional & up & over range of garage doors.







When ordering parts from this catalogue, please provide the relevant article number.

For other parts not shown in this catalogue, or any parts related queries, please contact:





**Product Services Dept
Hörmann (UK) Ltd
Gee Road
Coalville
Leicestershire
LE67 4JW**





**Tel: 01530 513030
Fax: 01530 513031**

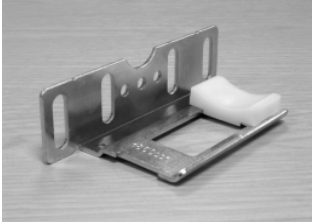
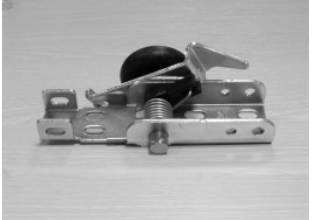



Errors & exceptions omitted



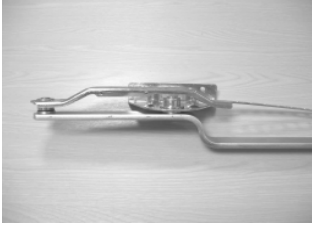

Article	Description	Part No	List Price
	<p>All cylinders are available with the option of being keyed alike at a cost of £49.50 per door. Extra keys are a cost of £10. Keyed alike cylinders are subject to a lead-time of 2 weeks</p> <p>Cylinder 40mm</p> <p>Used on 2001, 2003, 2003, 2004, 2104, 2101, 2204, 2404, 2504 doors</p>	1020001	£25.00
	<p>Cylinder 45mm</p> <p>Used on 2002 doors</p>	1020002	£25.00
	<p>Cylinder 50mm</p> <p>Used on 2009, 2016, 2026, 2045, 2109, 2119, 210, 2110 doors</p>	1020003	£32.00
	<p>Cylinder 60mm</p> <p>Used on 2005, 2007, 2008, 2011, 2013, 2014, 2019, 2020, 2024, 2025, 2034, 2035, 2040, 2041, 2042, 2044, 2047, 2048, 2049, 2050, 2114, 2121, 2122 doors</p>	7002909	£35.00
	<p>Cylinder 60mm</p> <p>Used on steel side doors</p>	719269	£35.00
	<p>Galvanised closer angle for unframed doors</p> <p>Specify door width when ordering</p>	Various	£8.80

Article	Description	Part No	List Price
	Brass clip	1071000	£0.80
	Steel washer for canopy link arm	1853000	£0.60
	Nylon bush for canopy link arm	1852000	£0.90
	Hold up clip for canopy door on manual operation	1617000	£3.80
	Canopy torsion spring assembly		
	Specify door width when ordering	Various	£70.00
	Canopy vertical track cover profile	7003298	£22.00

Article	Description	Part No	List Price
	Plastic pop rivet for canopy vertical track cover profile	1835000	£0.80
	Canopy latch assembly	1161805	£12.00
	Canopy latch keep	1860000	£5.00
	Canopy spring loaded roller		
	Left	1891013	£10.50
	Right	1891014	£10.50
	Roller cable for canopy doors	1877015	£5.00
	Canopy cable drum		
	Left	1805003	£8.00
	Right	1805004	£8.00

Article	Description	Part No	List Price
	Locking rods for Canopy & Retractable upto 9 x 7		
	Specify door type, style & size when ordering	Various	£7.00
	Canopy arm & track assembly		
	Left	7004212	£25.00
	Right	7004213	£25.00
	Canopy vertical track		
	Left	1816003	£16.00
	Right	1816004	£16.00
	Canopy link arm	1849212	£7.40
	Canopy link arm pivot bracket	1853801	£6.20
	Canopy cable drum bracket		
	Left	1864013	£7.60
	Right	1864014	£7.60

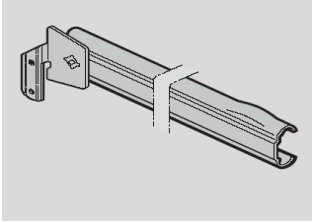
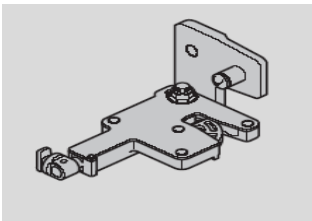
Article	Description	Part No	List Price
	Lifting arm for retractable doors		
	6'4" Left	1049511	£25.00
	6'4" Right	1049512	£25.00
	6'6" Left	1049521	£25.00
	6'6" Right	1049524	£25.00
	7'0" Left	1049553	£25.00
	7'0" Right	1049554	£25.00
	Lifting arm for retractable plus doors - universal		
	6'4"	1049581	£23.00
	6'6"	1049582	£23.00
	7'0"	1049584	£23.00
	Spring cover		
	Retractable	1248010	£8.40
	Retractable plus	1248810	£8.40
	Retractable top weather seal		
	6'4"	1882011	£7.50
	6'6"	1882012	£7.50
	7'0"	1882013	£7.50
	Retractable plus top weather seal		
	6'4"	7004637	£7.50
	6'6"	7004638	£7.50
	7'0"	7004639	£7.50
	Canopy unframed bottom seal		
	6'4"	7003302	£11.00
	6'6"	7003303	£11.00
	7'0"	7003304	£11.00

Article	Description	Part No	List Price	
	Retractable unframed bottom seal			
	6'4"	7003299	£5.00	
	6'6"	7003300	£5.00	
	7'0"	7003301	£5.00	
	Retractable plus unframed bottom seal			
	6'4"	7004640	£11.00	
	6'6"	7004641	£11.00	
	7'0"	7004642	£11.00	
	Retractable tracks & pivot points			
	Note that in most cases a track & pivot point should be ordered together as a special tool is required to join the two			
	Pivot point left for unframed door	1276001	£5.00	
	Pivot point right for unframed door	1276002	£5.00	
	Pivot point left for framed door	1076801	£5.00	
	Pivot point right for framed door	1076802	£5.00	
	Track for retractable 6'4"	1078810	£10.00	
	Track for retractable 6'6"	1078820	£10.00	
	Track for retractable 7'0"	1078851	£10.00	
	Track for retractable plus 6'4"	1078801	£10.00	
	Track for retractable plus 6'6"	1078802	£10.00	
	Track for retractable plus 7'0"	1078803	£10.00	
		Retractable latch		
		Steel doors, left	1037313	£18.80
		Steel doors, right	1037314	£18.80
Timber & GRP doors, left		1148313	£18.80	
Timber & GRP doors, right		1148314	£18.80	
	Retractable roller			
	Left	1084803	£12.00	
	Right	1084804	£12.00	

Article	Description	Part No	List Price
	Retractable spring cluster		
	Specify id no on existing spring when ordering replacement	Various	£32.50
	Universal track support for retractable & retractable plus	1089800	£6.80
	Rear spacer rail for retractable / retractable plus		
	6'06"	1087891	£12.60
	6'08"	1087893	£12.60
	6'10"	1087894	£12.60
	7'00"	1087801	£12.60
	7'03"	1087809	£12.60
	7'05"	1087813	£12.60
	7'06"	1087816	£12.60
	7'08"	1087822	£12.60
	8'00"	1087892	£12.60
	9'00"	1087864	£12.60
	Blister packs		
	For canopy doors:		
	Steel doors on steel frames	16803	£26.50
	Steel doors on timber frames	16804	£29.00
	Timber/GRP doors on steel frames	16813	£26.50
	Timber/GRP doors on timber frames	16814	£29.00
	For retractable doors:		
	Steel doors on steel frames	16801	£26.50
	Steel doors on timber frames	16802	£29.00
	Timber/GRP doors on steel frames	16811	£26.50
	Timber/GRP doors on timber frames	16812	£29.00
	For retractable plus doors:		
	Steel doors on steel frames	16805	£26.50
	Steel doors on timber frames	16806	£29.00
	Timber/GRP doors on steel frames	16815	£26.50
	Timber/GRP doors on timber frames	16816	£29.00
	Bottom weather strip with screws	1578588	£31.00

Article	Description	Part No	List Price
---------	-------------	---------	------------

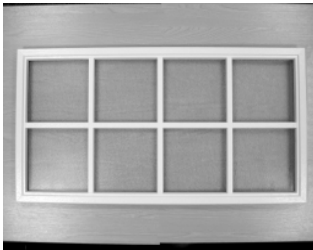

Windows for Ilkley doors	7'00" - 7004110		£95.00
	7'06" - 7004111		£99.00

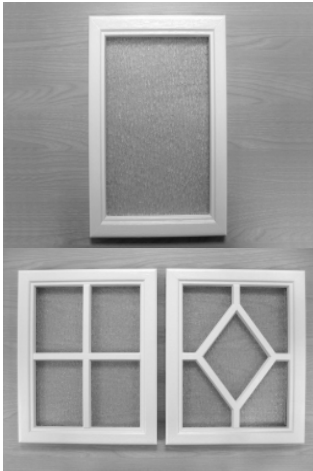

Windows for 2304 Georgian door	Plain - 1709301		£44.50
	Diamond - 1709303		£44.50
	Square - 1709305		£44.50

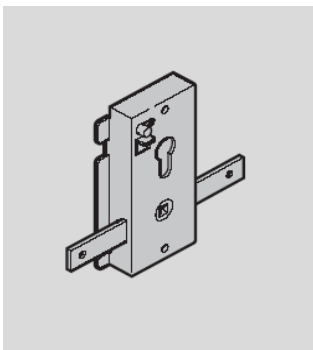

Lockbodys		
For 2001 / 2003 / 2004 / 2104 / 2204 / 2304	1019000	£28.00
as above but with 40mm cylinder included	1019001	£37.50
For 2002 / Timber & GRP	1019100	£28.00

Article	Description	Part No	List Price
---------	-------------	---------	------------

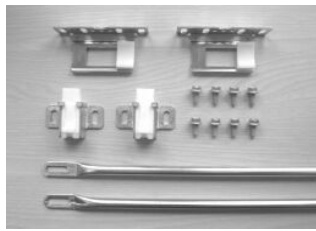

Retro fit 4 - point locking kit
Available for retractable, retractable plus & canopy doors

When ordering, specify type, style & size of door the kit is required for. If door is a canopy, please specify if it is fitted to a 75mm or 60mm frame

Various		£42.00
---------	--	--------

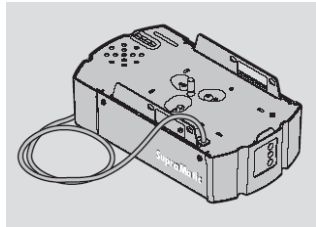

Operator head units

Note that these units do not include handsets, aerial equipment, bulbs or fixings

Supramatic E v1	435052	£243.00
Supramatic E v2	435846	£243.00
Supramatic P v2	435906	£259.00
Supramatic H v2	435951	£316.00
Promatic v2	435666	£198.00
Promatic Akku v2	435745	£198.00
Ecostar	435267	£198.00



Bulbs

Ecostar / Ecomatic / Promatic (10w 24v bayonet)	438313	£4.30
Supramatic v1 (40w Edison screw)	438195	£6.50
Supramatic v2 (Halogen)	7007373	£5.00



Batteries for hand transmitters

12v for HS2 / HS4 / HSM2 / HSM4	7005059	£3.50
6v for HSE2	7004674	£3.50
3v for RSE2	7005058	£5.80

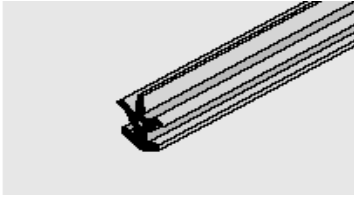
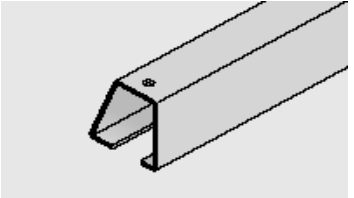
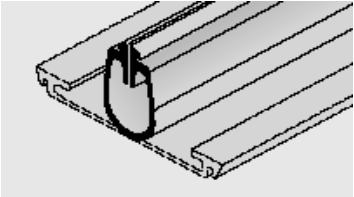
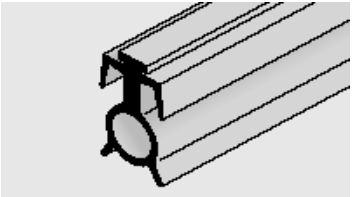
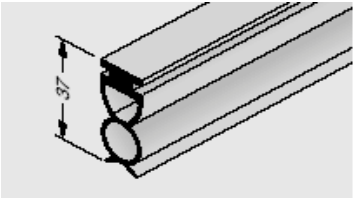
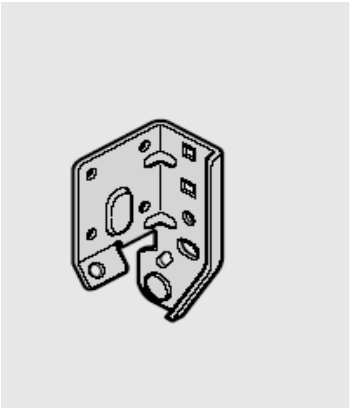
Article	Description	Production Date	Article No	List Price
	Intermediate panel seal for insulated doors	01.06.1999 -	3045684	£3.50 /metre
	Carrier for bottom weather seal	01.06.1999 -	3041117	£9.50 /metre
	Bottom weather seal for LTE, LPU, & EPU doors. Not for LTH, doors with wicket or safety edges	01.06.1999 -	3045652	£46 /metre
	Ventilated seal for LTH doors	01.06.1999 -	3040107	£57 /metre
	Bottom weather seal for LTE, LPU & EPU doors when used with safety edges	01.06.1999 -	3054462	£32 /metre
	Bottom roller bracket for N, L or H			
	Right	01.06.1999 -	3047248	£11.50
	Left	01.06.1999 -	3047249	£11.50

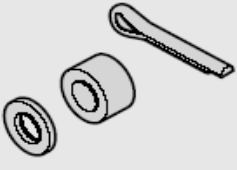
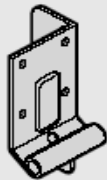
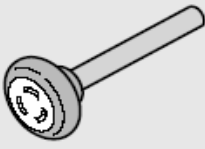
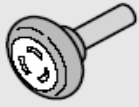
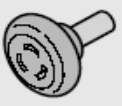
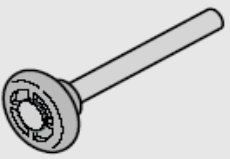
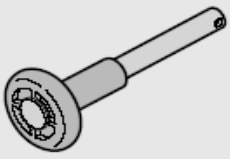
Article	Description	Production Date	Article No	List Price
	Pin & spacer for bottom bracket on N, L or H	01.06.1999 -	3054028	£5.00
	Bottom roller bracket for Z			
	Right	01.06.1999 -	3055053	£8.50
	Left	01.06.1999 -	3055052	£8.50
	Bottom wheel for Z	01.06.1999 -	3047259	£9.50
	Bottom wheel for N, L or H	01.06.1999 -	3040311	£6.50
	Intermediate wheel for N, L & Z	01.06.1999 -	3039956	£6.50
	Intermediate wheel for H	01.06.1999 -	3041112	£11.00
	Top wheel for H	01.06.1999 -	3041113	£12.00

Article	Description	Production Date	Article No	List Price
---------	-------------	-----------------	------------	------------

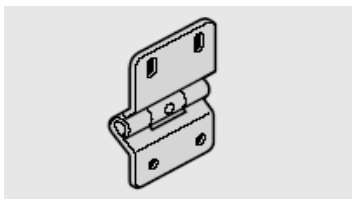

Panel hinge (not for LTH & wicket doors	01.06.1999 -	3045117	£7.00
---	--------------	---------	-------

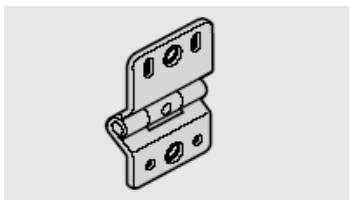

Panel hinge for LTH	01.06.1999 -	3045119	£7.00
---------------------	--------------	---------	-------

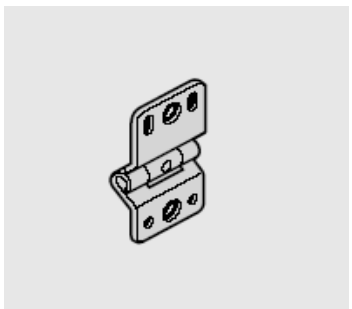

Panel hinge for wicket door	01.06.1999 -	3040909	£6.50
-----------------------------	--------------	---------	-------

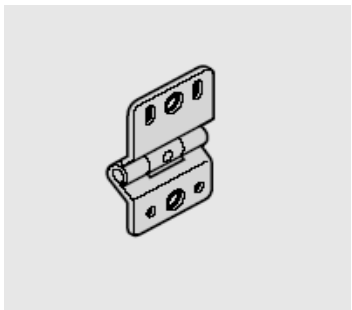

Panel hinge for doors with wicket	01.06.1999 -	3056279	£7.00
-----------------------------------	--------------	---------	-------

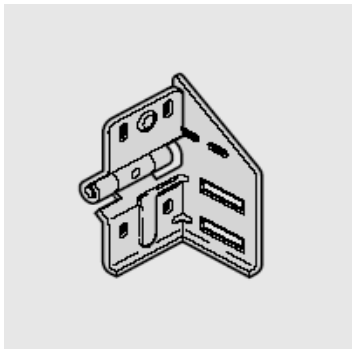

Intermediate roller bracket for N, L or Z

Right	01.06.1999 -	3045114	£10.00
Left	01.06.1999 -	3045115	£10.00

Article	Description	Production Date	Article No	List Price
---------	-------------	-----------------	------------	------------

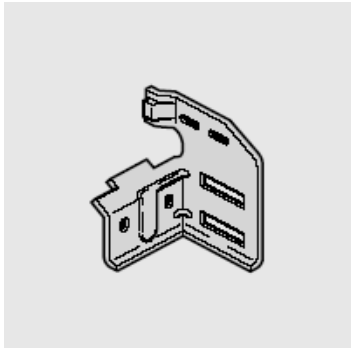

Top roller bracket for N

Right	01.06.1999 -	3045112	£12.00
Left	01.06.1999 -	3045113	£12.00

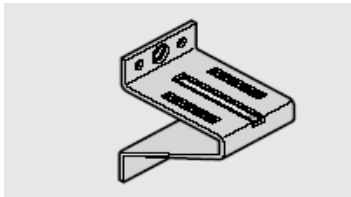

Top & intermediate roller bracket for H

	01.06.1999 -	3039947	£9.00
--	--------------	---------	-------

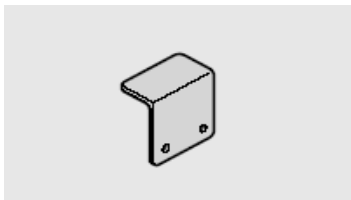

Landing plate for stop buffer on H

	01.06.1999 -	3041158	£6.50
--	--------------	---------	-------

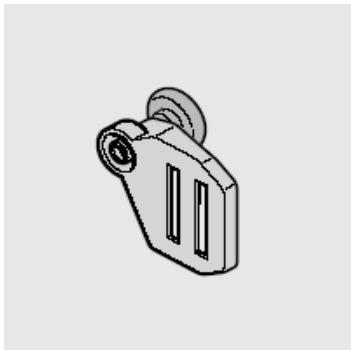

Top roller & bracket for N

Right	01.06.1999 -	3045403	£14.00
Left	01.06.1999 -	3045402	£14.00

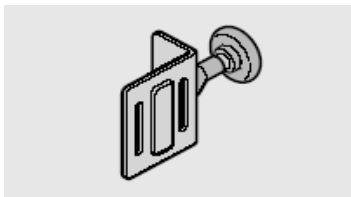



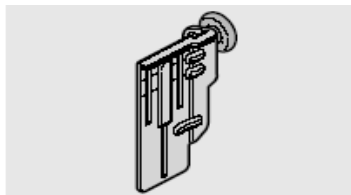

Top roller & bracket for L



	01.06.1999 -	3047254	£11.50
--	--------------	---------	--------

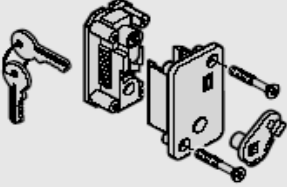
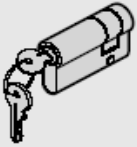
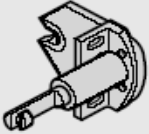
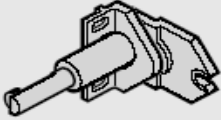

Top roller & bracket for Z

Right	01.06.1999 -	3047261	£11.50
Left	01.06.1999 -	3047260	£11.50

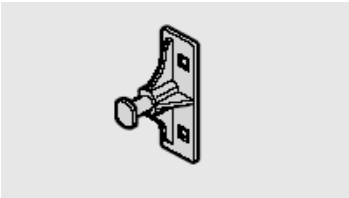
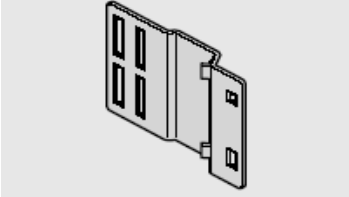
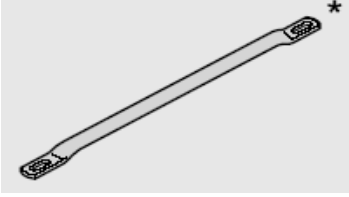
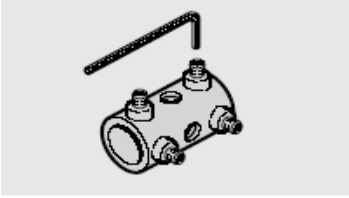
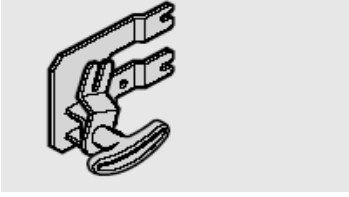
Article	Description	Production Date	Article No	List Price
	Roller holder	01.06.1999 -	3039099	£7.00
	Roller holder for H	01.06.1999 -	3039948	£6.50
	Lock body & cylinder	01.06.1999 -	3045163	£58.00
	<p>All cylinders are available with the option of being keyed alike at a cost of £49.50 per door. Extra keys are a cost of £10. Keyed alike cylinders are subject to a leadtime of 2 weeks</p>			
	Cylinder 40mm	01.06.1999 -	1020001	£25.00
	Rotary latch for H	01.06.1999 -	3017389	£29.00
	Rotary latch for N, L & Z	01.06.1999 -	3047226	£29.00
	Latch bolt for H	01.06.1999 -	3045198	£12.00

Article	Description	Production Date	Article No	List Price
	Latch bolt for N, L & Z	01.06.1999 -	3047225	£12.00
	Latch bolt plate	01.06.1999 -	3047258	£7.00
	Locking rod cut to length *	01.06.1999 -	3040280	£17.50
	Locking rod coupling	01.06.1999 -	3046238	£12.00
	Internal T bar for door with wicket			
	Right	01.06.1999 -	3054119	£38.00
	Left	01.06.1999 -	3054120	£38.00
	Internal grab handle	01.06.1999 -	3047367	£6.50

Article	Description	Production Date	Article No	List Price
---------	-------------	-----------------	------------	------------

Complete Fitting Packs

N Track, RM = 1875			3047469	£184.00
N Track, RM = 2000			3047468	£192.00
N Track, RM = 2125			3047467	£199.00
N Track, RM = 2250			3047466	£206.00
N Track, RM = 2375			3047465	£214.00
N Track, RM = 2500			3047464	£220.00
L Track, RM = 1875			3047480	£273.00
L Track, RM = 2000			3047479	£281.00
L Track, RM = 2125			3047478	£289.00
L Track, RM = 2250			3047477	£296.00
L Track, RM = 2375			3047476	£303.00
L Track, RM = 2500			3047475	£309.00
Z Track, RM = 1875			3053106	£184.00
Z Track, RM = 2000			3053105	£192.00
Z Track, RM = 2125			3053104	£199.00
Z Track, RM = 2250			3053103	£206.00
Z Track, RM = 2375			3053102	£214.00
Z Track, RM = 2500			3053101	£220.00
Other standard sizes & special sizes by request.	RM = Ordering size			

Article	Description	Production Date	Article No	List Price
---------	-------------	-----------------	------------	------------

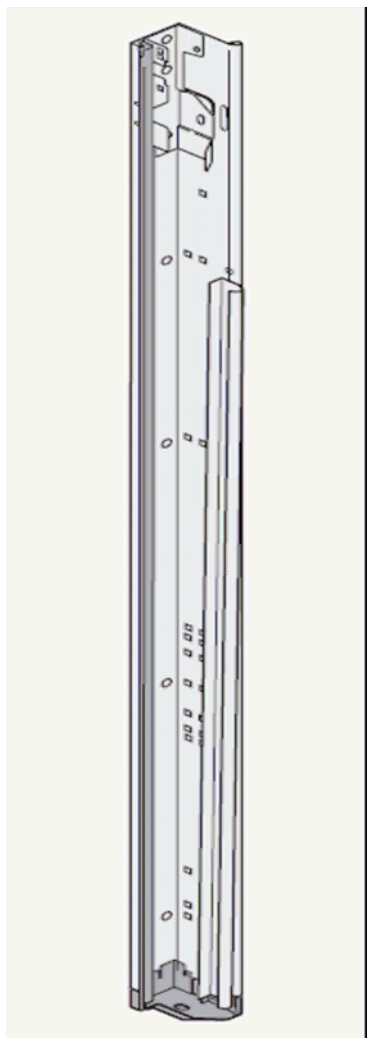

Vertical track for N

Calculated as ordering height (RM) + 210

Right	01.06.1999 -	3047352	£91 /metre
Left	01.06.1999 -	3047351	£91 /metre

Article	Description	Production Date	Article No	List Price
---------	-------------	-----------------	------------	------------

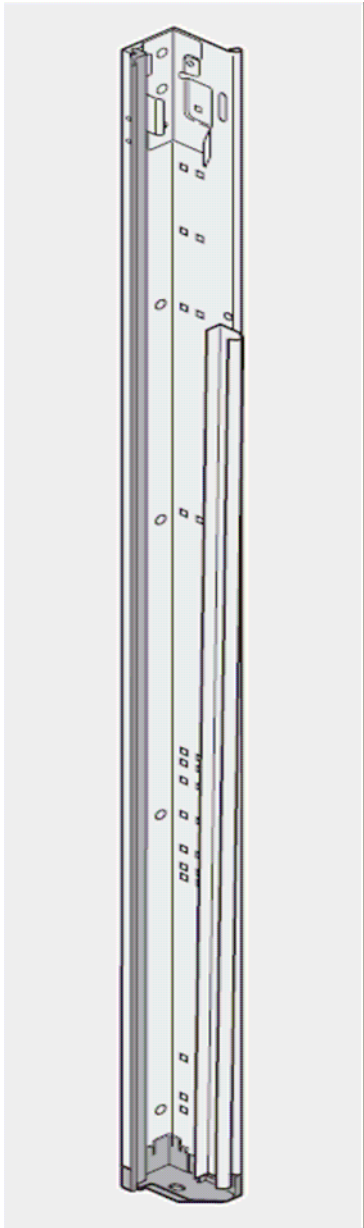

Vertical track for L

Calculated as ordering height (RM) + 100

Right	01.06.1999 -	3057681	£91 /metre
Left	01.06.1999 -	3057680	£91 /metre

Article	Description	Production Date	Article No	List Price
---------	-------------	-----------------	------------	------------

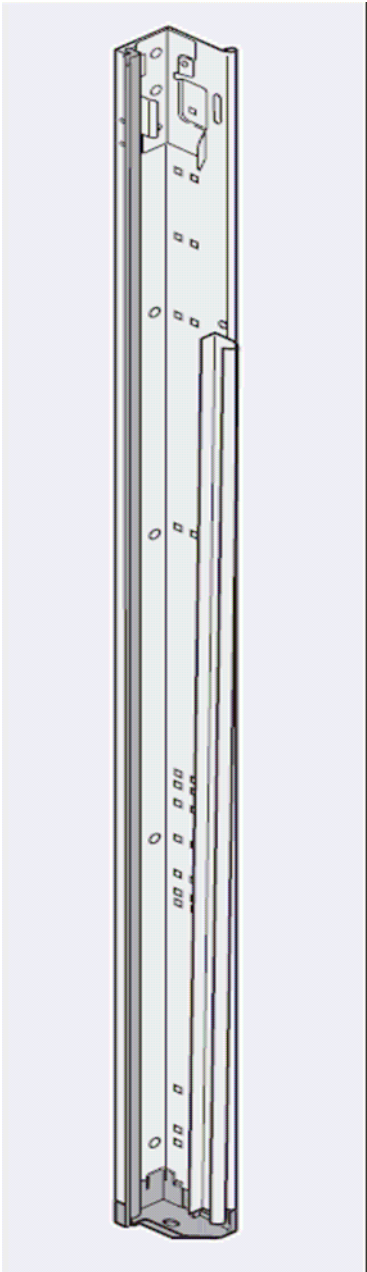

Vertical track for Z

Calculated as ordering height (RM) + 100

Right	01.09.1999 -	3057674	£91 /metre
Left	01.09.1999 -	3057673	£91 /metre

Article	Description	Production Date	Article No	List Price
---------	-------------	-----------------	------------	------------

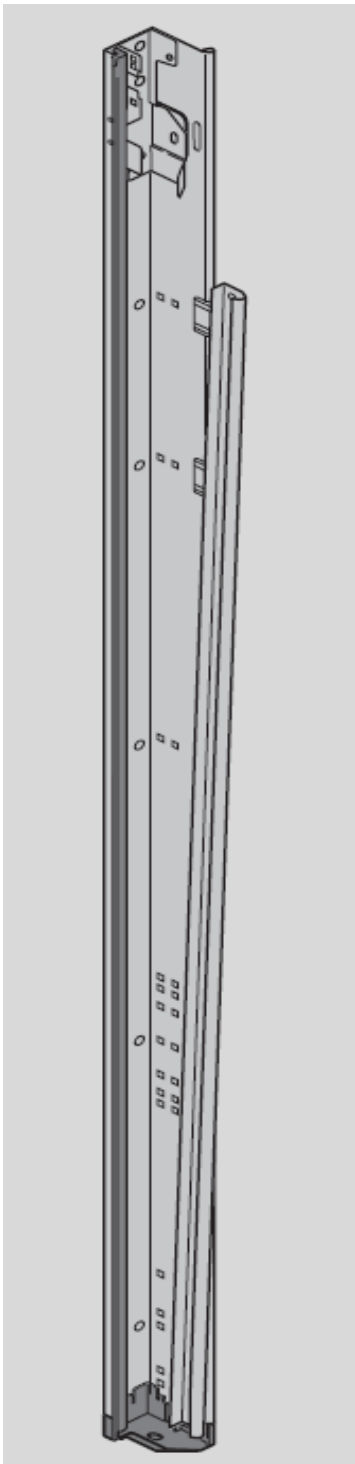

Vertical track for H

Calculated as track height
(LH) + 97

Right	01.06.1999 -	3053693	£107 /metre
Left	01.06.1999 -	3053692	£107 /metre

Article	Description	Production Date	Article No	List Price
---------	-------------	-----------------	------------	------------

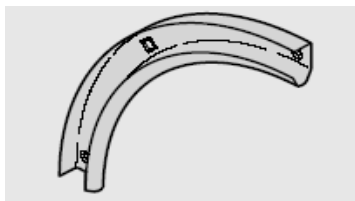

90 degree track radius	01.06.1999 -	3038297	£37.50
------------------------	--------------	---------	--------

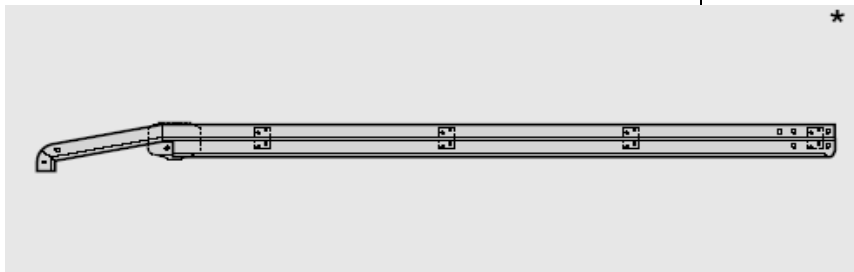

Calculated as ordering height
(RM) + 470

Horizontal track for N	Right	01.06.1999 -	3047354	£78 /metre
	Left	01.06.1999 -	3047353	£78 /metre

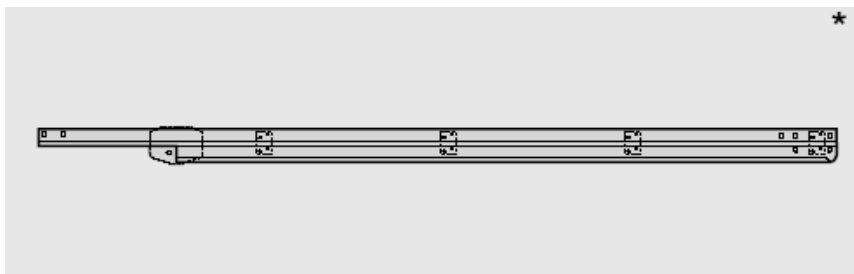

Calculated as ordering height
(RM) + 470 for Z

Calculated as ordering height
(RM) + 550 for L

Horizontal track for L, Z	Right	01.06.1999 -	3047097	£78 /metre
	Left	01.06.1999 -	3047098	£78 /metre

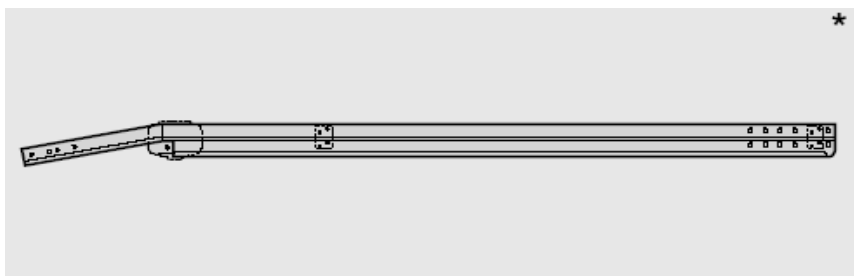

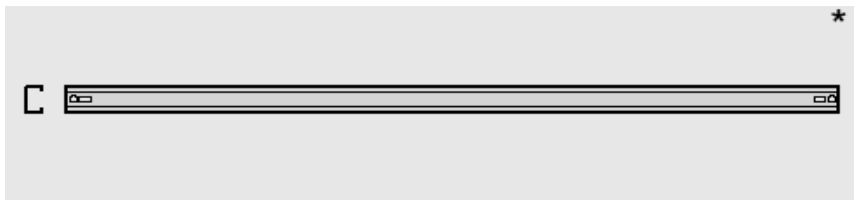

When ordering please quote
original order no and / or full
details from door ID plate

Horizontal track for H	Right	01.06.1999 -	3053697	£78 /metre
	Left	01.06.1999 -	3053696	£78 /metre

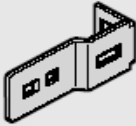
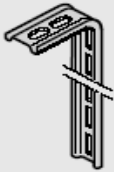

Rear spacer bar	01.06.1999 -	3038670	£30.50 /metre
-----------------	--------------	---------	---------------

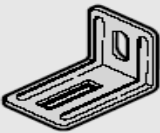
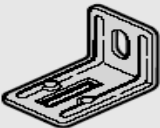
Article	Description	Production Date	Article No	List Price
	Spacer rail fixing bracket	01.06.1999 -	3047042	£6.50
	Horizontal track support	01.06.1999 -	3047047	£11.00
	Horizontal track support bracket	01.06.1999 -	3047045	£5.00
	Clamping plate for horizontal track	01.06.1999 -	3047043	£3.50
	Frame fixing bracket N, L & Z	01.06.1999 -	3054161	£4.00
	Frame fixing bracket H	01.06.1999 -	3054146	£6.00

Article	Description	Production Date	Article No	List Price
---------	-------------	-----------------	------------	------------

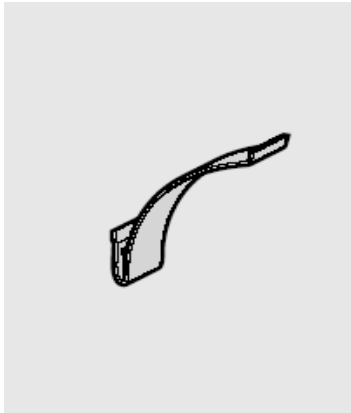

Order the metal or plastic one
depending on which track
casting you have

Buffer spring for L, Z (metal)	01.06.1999 -	3045996	£7.00
Buffer spring for L, Z (plastic)	20.03.2007 -	3072580	£3.50

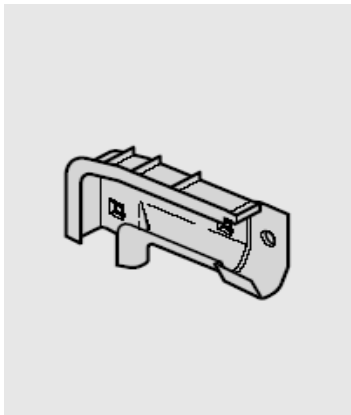

Track casting for L, Z

Moulded plastic

Right	12.03.2007 -	3072563	£14.00
Left	12.03.2007 -	3072562	£14.00



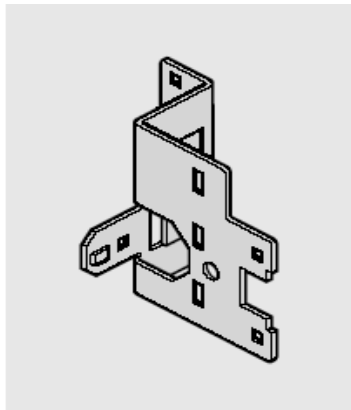

Cable drum finger protection
for L

	01.06.1999 -	3047377	£6.00
--	--------------	---------	-------

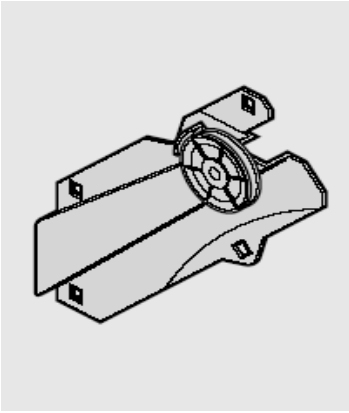
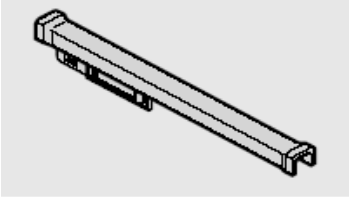

Spring bracket for L

Right	01.06.1999 -	3057524	£14.00
Left	01.06.1999 -	3057523	£14.00

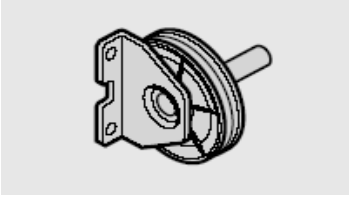
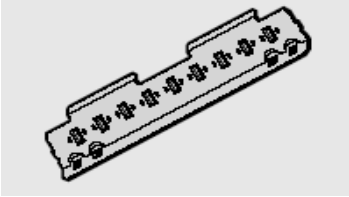
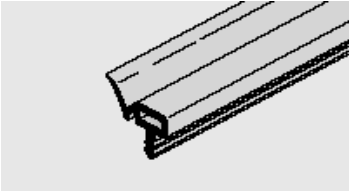
Article	Description	Production Date	Article No	List Price
	Cable pulley for L			
	Right	01.06.1999 -	3047435	£42.00
	Left	01.06.1999 -	3047434	£42.00
	Track end stop for Z	01.09.1999 -	3047253	£7.50
	Cable clasp for Z	01.09.1999 -	3045342	£6.00
	Cable pulley for Z	01.09.1999 -	3047257	£12.00
	Tension plate for Z	01.09.1999 -	3047229	£6.00
	Seal for vertical frame	01.06.1999 -	3051888	£6.50 /metre

Article	Description	Production Date	Article No	List Price
---------	-------------	-----------------	------------	------------

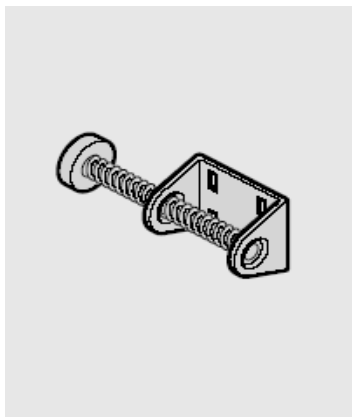

Spring buffer for H	01.06.1999 -	3055175	£26.00
---------------------	--------------	---------	--------

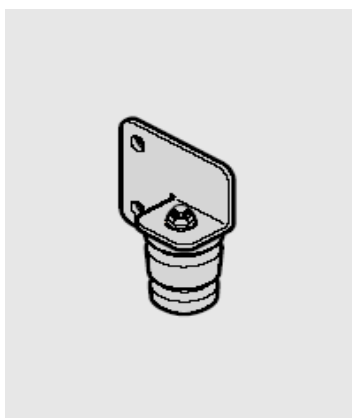

Buffer stop for H

Right	01.06.1999 -	3040531	£55.00
Left	01.06.1999 -	3040532	£55.00

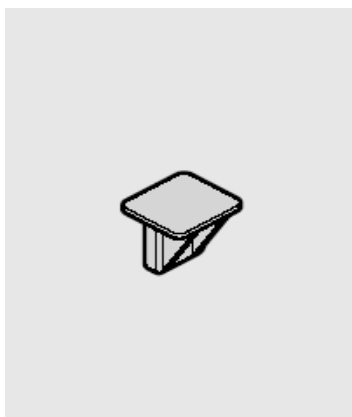



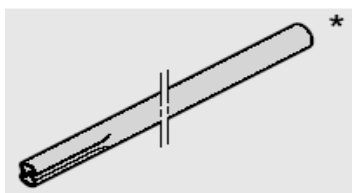

Buffer stop landing plate	01.06.1999 -	3039706	£9.00
---------------------------	--------------	---------	-------

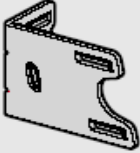

Spring shaft

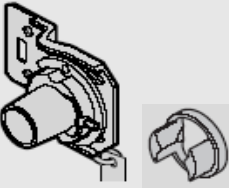
Right	01.06.1999 -	3051055	£46 /metre
Left	01.06.1999 -	3051054	£46 /metre

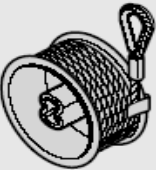
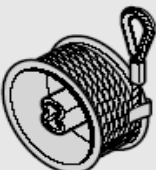
Article	Description	Production Date	Article No	List Price
	Spring shaft holder	01.06.1999 -	3047375	£8.00
	Spring shaft holder bracket	01.06.1999 -	3047378	£7.00
	Spring shaft coupling	01.06.1999 -	3007014	£19.00
	Safety Brake			
	Right	01.06.1999 -	3047243	£65.00
	Left	01.06.1999 -	3047242	£65.00
	Collar should also be ordered (small picture)	01.06.1999 -	3047224	£3.00
	Spring tightening cone	01.06.1999 -	3042114	£19.00
	Cable drum for N, L upto door height of 2250			
	Right	01.06.1999 - 01.03.2005	3047427	£50.00
	Left	01.06.1999 - 01.03.2005	3047426	£50.00
	Cable drum for N, L upto door height of 2250			
	Right	01.03.2005 -	3064291	£43.00
	Left	01.03.2005 -	3064290	£43.00

Article	Description	Production Date	Article No	List Price
---------	-------------	-----------------	------------	------------

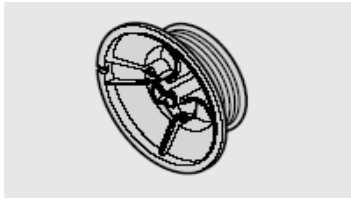

Cable drum for H

Right	01.06.1999 -	3047429	£75.00
Left	01.06.1999 -	3047428	£75.00

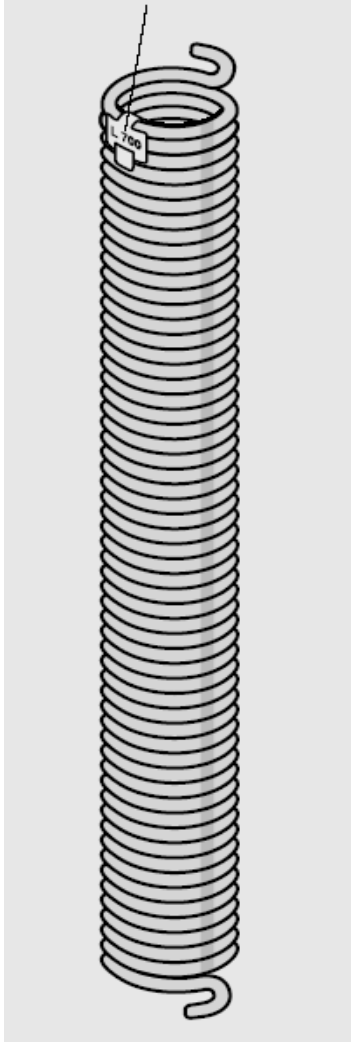

Torsion springs for N, L & H

R700	01.06.1999 -	3051014	108.00
L700	01.06.1999 -	3051015	108.00
R701	01.06.1999 -	3051016	102.00
L701	01.06.1999 -	3051017	102.00
R702	01.06.1999 -	3051018	104.00
L702	01.06.1999 -	3051019	104.00
R703	01.06.1999 -	3051020	104.00
L703	01.06.1999 -	3051021	104.00
R704	01.06.1999 -	3051022	124.00
L704	01.06.1999 -	3051023	124.00
R705	01.06.1999 -	3051024	143.00
L705	01.06.1999 -	3051025	143.00
R706	01.06.1999 -	3051026	136.00
L706	01.06.1999 -	3051027	136.00
R707	01.06.1999 -	3051028	173.00
L707	01.06.1999 -	3051029	173.00
R708	01.06.1999 -	3051030	216.00
L708	01.06.1999 -	3051031	216.00
R709	01.06.1999 -	3053617	261.00
L709	01.06.1999 -	3053618	261.00
R720	01.06.1999 -	3051032	124.00
L720	01.06.1999 -	3051033	124.00
R721	01.06.1999 -	3051034	124.00
L721	01.06.1999 -	3051035	124.00
R722	01.06.1999 -	3051036	124.00
L722	01.06.1999 -	3051037	124.00
R723	01.06.1999 -	3051038	126.00
L723	01.06.1999 -	3051039	126.00
R724	01.06.1999 -	3051040	159.00
L724	01.06.1999 -	3051041	159.00
R725	01.06.1999 -	3051042	216.00
L725	01.06.1999 -	3051043	216.00
R726	01.06.1999 -	3051044	261.00
L726	01.06.1999 -	3051045	261.00
R727	01.06.1999 -	3051046	238.00
L727	01.06.1999 -	3051047	238.00
R728	01.06.1999 -	3051048	238.00
L728	01.06.1999 -	3051049	238.00
R729	01.06.1999 -	3053619	288.00
L729	01.06.1999 -	3053620	288.00
R743	05.06.2000 -	3054471	162.00
L743	05.06.2000 -	3054472	162.00
R744	05.06.2000 -	3054473	200.00
L744	05.06.2000 -	3054474	200.00
R748	05.06.2000 -	3054475	175.00
L748	05.06.2000 -	3054476	175.00
R749	05.06.2000 -	3054477	236.00
L749	05.06.2000 -	3054478	236.00

Please quote tag no on existing spring when ordering. If this is not available, please obtain spring no's from door ID plate, or quote door type / age / style & size so correct spring can be ascertained

Article	Description	Production Date	Article No	List Price
---------	-------------	-----------------	------------	------------

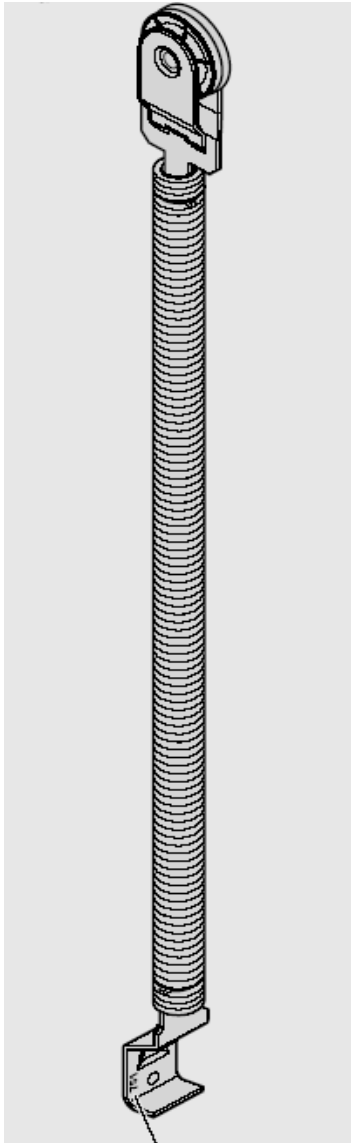

Please note spring no at
bottom of existing spring
when ordering replacements

Tension spring for Z

740	01.03.2004 -	3061848	100.00
741	01.03.2004 -	3061849	102.00
751	01.09.1999 -	3051059	102.00
752	01.09.1999 -	3051060	104.00
753	01.09.1999 -	3051061	110.00
754	01.09.1999 -	3051062	112.00
755	01.09.1999 -	3051063	115.00
756	01.09.1999 -	3051064	141.00
757	01.03.2006 -	3065910	164.00
758	01.03.2006 -	3065911	174.00
760	01.09.1999 -	3051065	110.00
761	01.09.1999 -	3051066	116.00
762	01.09.1999 -	3051067	117.00
763	01.09.1999 -	3051068	121.00
764	01.09.1999 -	3051069	124.00
765	01.09.1999 -	3051070	127.00
766	01.09.1999 -	3051071	155.00
767	01.03.2006 -	3065912	189.00
768	01.03.2006 -	3065913	209.00
770	01.03.2006 -	3055156	136.00
771	01.03.2006 -	3055157	142.00
772	01.02.2000 -	3054887	142.00
773	01.02.2000 -	3054888	150.00
776	01.02.2000 -	3054889	172.00
777	01.02.2000 -	3054890	177.00
778	01.03.2006 -	3065914	236.00
779	01.03.2006 -	3065915	251.00
780	01.03.2006 -	3056282	150.00
781	01.03.2006 -	3056283	156.00
782	01.06.2003 -	3056284	156.00
783	01.06.2003 -	3056280	167.00
786	01.06.2003 -	3056281	206.00
787	01.06.2003 -	3056285	215.00
788	01.03.2006 -	3065916	252.00
789	01.03.2006 -	3065917	290.00

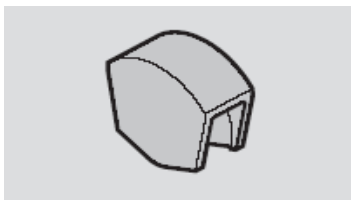

Spring wheel guard for Z	01.03.2006 -	3054869	£5.00
--------------------------	--------------	---------	-------

Article

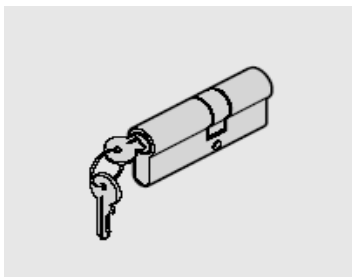

Cylinder for profile 1 & LTH side doors & wicket doors (35mm + 30mm)	01.06.1999 -	3042227	£33.00
--	--------------	---------	--------

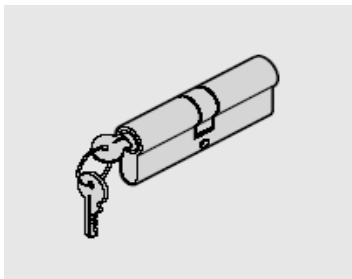

Cylinder for profile 2 side doors (35mm + 35mm)	01.06.1999 -	3043298	£37.50
---	--------------	---------	--------

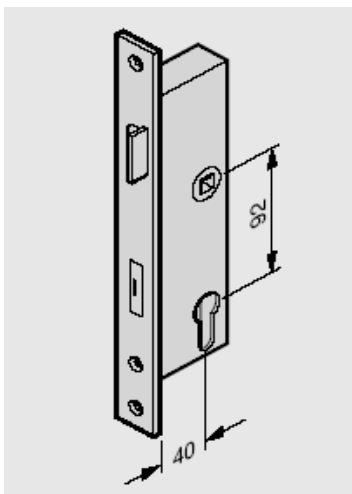

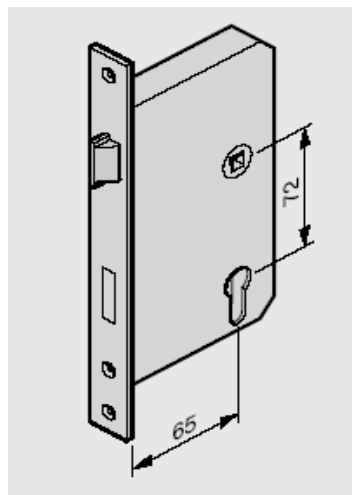

Side door & wicket door lock body	01.06.1999 -	3070038	£56.00
-----------------------------------	--------------	---------	--------



LTH side door lockbody for doors manufactured up to 28.02.2000 only

If LTH side door manufactured after 28.02.2000, use part 3070038

Right	01.06.1999 -	3040516	£46
Left	01.06.1999 -	3040438	£46

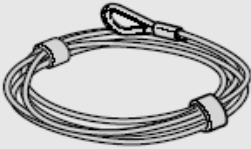
Article	Description	Production Date	Article No	List Price
	Lever / lever handle shaft			
	For wicket doors	01.06.1999 -	3053786	£6.00
	For side doors	01.06.1999 -	3053778	£6.00
	Lever / knob handle shaft			
	for wicket & side door	01.06.1999 -	3053780	£14.00
	Cables for N track			
	upto 2250 high	01.03.2005 -	3064375	£17.50
	over 2250 high	01.06.1999 -	3064376	£20.00
	Cables for L track			
	Upto 2065 high	01.03.2005 -	3064358	£53.50
	Upto 2190 high	01.03.2005 -	3064359	£59.00
	Upto 2240 high	01.03.2005 -	3064360	£59.00
	Upto 2250 high	01.03.2005 -	3064361	£59.00
	Upto 2490 high	01.06.1999 -	3064362	£59.00
	Upto 2830 high	01.06.1999 -	3064363	£66.00
	Upto 3000 high	01.06.1999 -	3064364	£69.00
	Cables for Z track			
	Door height 1875	01.02.2001 -	3064346	£53.50
	Door height 1955	01.07.2002 -	3064347	£53.50
	Door height 2000	01.06.1999 -	3064348	£53.50
	Door height 2080	01.07.2002 -	3064349	£53.50
	Door height 2125	01.06.1999 -	3064350	£56.50
	Door height 2205	01.03.2003 -	3064351	£56.50
	Door height 2250	01.06.1999 -	3064352	£56.50
	Door height 2375	01.02.2001 -	3064353	£56.50
	Door height 2500	01.02.2001 -	3064354	£56.50
	Door height 2625	01.06.2003 -	3064355	£56.50
	Cables for H track			
	Upto 1875 high	01.06.1999 -	3064365	£45.00
	Upto 2000 high	01.06.1999 -	3064366	£48.00
	Upto 2125 high	01.06.1999 -	3064367	£48.00
	Upto 2250 high	01.06.1999 -	3064368	£48.00
	Upto 2375 high	01.06.1999 -	3064369	£48.00
	Upto 2500 high	01.06.1999 -	3064370	£50.50
	Upto 2625 high	01.06.1999 -	3064371	£50.50
	Upto 2750 high	01.06.1999 -	3064372	£50.50
	Upto 2875 high	01.06.1999 -	3064373	£53.50
	Upto 3000 high	01.06.1999 -	3067374	£53.50

All cables are priced per pair

Article	Description	Production Date	Article No	List Price
---------	-------------	-----------------	------------	------------

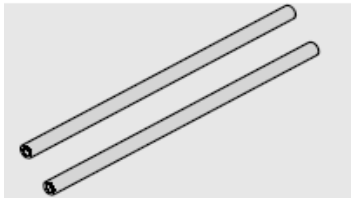

Spring tensioning bars	01.06.1999 -	3034178	£8.00
------------------------	--------------	---------	-------

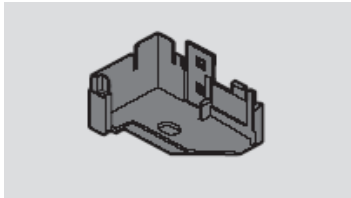

Vertical frame feet

Right	13.03.2006 -	3065816	£8.50
Left	13.03.2006 -	3065815	£8.50