

**GARADOR**  
*The Garage Door People*

# Garador Roller Garage Doors

**1<sup>st</sup> March 2025**







Garador roller door range	4
Comparison table	5
Introducing GaraGlide	6
GaraGlide tubular motor and electrically operated	8
GaraGlide functions and features	10
GaraGlide optical sensors	12
GaraGlide easy installation	14
GaraGlide additional options	15
Introducing GaraRoll	16
GaraRoll chain driven operator and electrically operated	18
GaraRoll functions and features	20
GaraRoll additional options	24
DuraBelt anti-scratch system	26
GaraGlide and GaraRoll colour options	28
GaraGlide and GaraRoll profile options	30
BlueSecur app and GaraRoll accessories	32
The Garador range	35

Since the company's policy is one of continuous improvement of its products, we reserve the right to make any alterations. Copyright. No part of this brochure may be copied or reproduced without our prior written permission.

Our doors are for residential purposes only and not for commercial use.

## Introducing the Garador roller garage door range

Garador roller garage doors open vertically and roll into a compact box at the head of the garage door opening, requiring minimal space inside the garage. This space-saving design means you can make full use of the space inside your garage, as the ceiling area remains free and can be used for lighting or additional storage space.

Choose from two different models, the GaraRoll and the GaraGlide. The GaraRoll is our premium offering, with a chain driven motor and pressure sensitivity built-in, whilst the GaraGlide utilises a tubular motor and optical-sensor at a significant price advantage.



GARADOR *Introducing the Garador roller garage door range*

	GaraGlide	GaraRoll
Electrically operated door design	Tubular motor	Chain driven operator
Automatic safety reversal	Optical sensor built into floor seal	Force limitation built into operator
Standard emergency release	Crank handle	Pull cord
Hand transmitters	4-button bisecur	4-button bisecur
Maximum door width	5000 mm	6000 mm
Maximum door height	3100 mm	3100 mm
Door curtain (77 mm aluminium profile, PU foam filled)	•	•
Box cover as standard	•	•
Mechanical lock on barrel	•	•
Windlocks	•	•
Control panel with integral LED light	•	•
Suitable for fitting behind the opening	•	•
Suitable for fitting between the opening	•	•
DuraBelt anti-scratch system		•
Tension spring assembly		•
Low power consumption		•
Soft start and stop (enhanced service life)		•
Built-in bluetooth receiver and compatible with BlueSecur app		•
<b>Optional extras</b>		
External roller design	•	•
Additional fascia panel	•	•
Fitting compensation set	•	•
Exterior door release	•	•
Emergency battery		•
Manually operated door		•
Chamfered bottom profile		•
Audible intrusion alarm		•



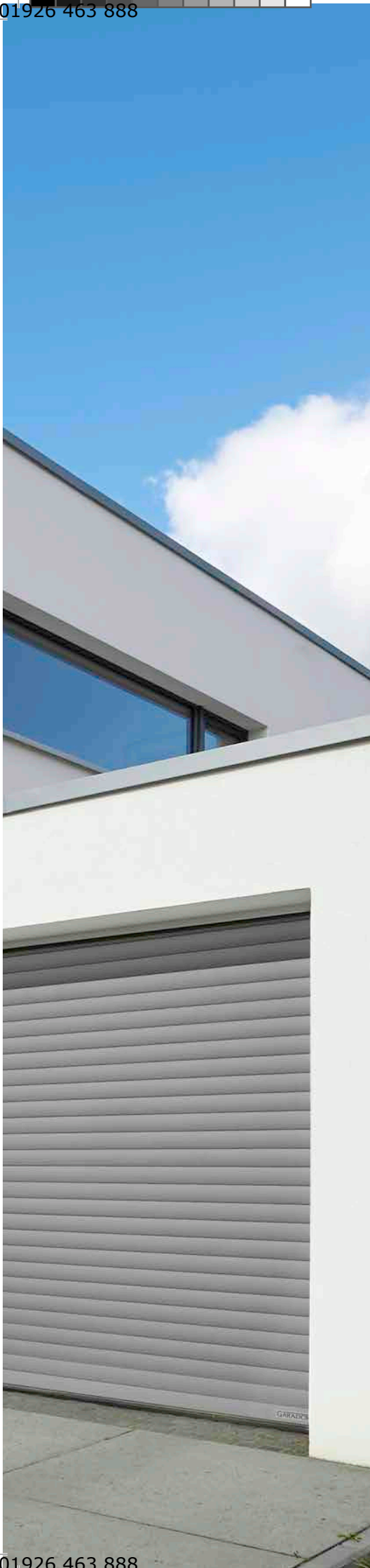

## GaraGlide roller doors Space-saving and easy to install

The GaraGlide combines a space saving design with the convenience of an electrically operated automatic door. The door lifts vertically and rolls into a box at the head of the garage door opening, providing more space in front of the garage and inside the garage than a traditional garage door design.

Choose from a full range of 20 standard colours and made-to-measure door sizes up to 5000 mm wide. Suitable for installation between or behind the opening, or with an externally fitted design. Available with either a standard or bisecur radio system.

# GaraGlide



GARADOR *Introducing GaraGlide*

## Tubular motor driven design

The GaraGlide has a tubular motor positioned at the end of the barrel, inside the box cover. It is equipped with a mechanically adjustable end-of-travel position, to set the doors open and close parameters. Supplied with crank handle for emergency release in case of power failure.



## Electrically operated with 2 standard hand transmitters

Electrically operated door design for convenience and ease of use. Comes with two 4-button bisecur remote hand transmitters and external control panel with integral LED light providing illumination inside the garage.



GARADOR *Designed for living, built to last*

# Designed for living, built to last



GARADOR *Designed for living, built to last*



### Integral LED Light

Control panel with integral LED courtesy light. Features 2-minute delay for ease of access to and from garage.



### Full box cover as standard

Made from aluminium foam-filled laths, the door curtain lifts vertically and rolls into a box at the head of the garage door opening. A complete box cover, encloses the door curtain, protecting it from damage and dirt when the door is open. Also prevents fingers from becoming caught or trapped, when the door is closed.



### Mechanical stop for security

A mechanical stop between the top lath and the roller barrel, prevents the door from being lifted by an intruder when in the closed position.



### A good seal all round

A sturdy rubber seal at the bottom of the door curtain and brush seals inside the guide rails, helps to prevent drafts inside the garage and stops unwanted leaves, dust and dirt blowing into the garage.

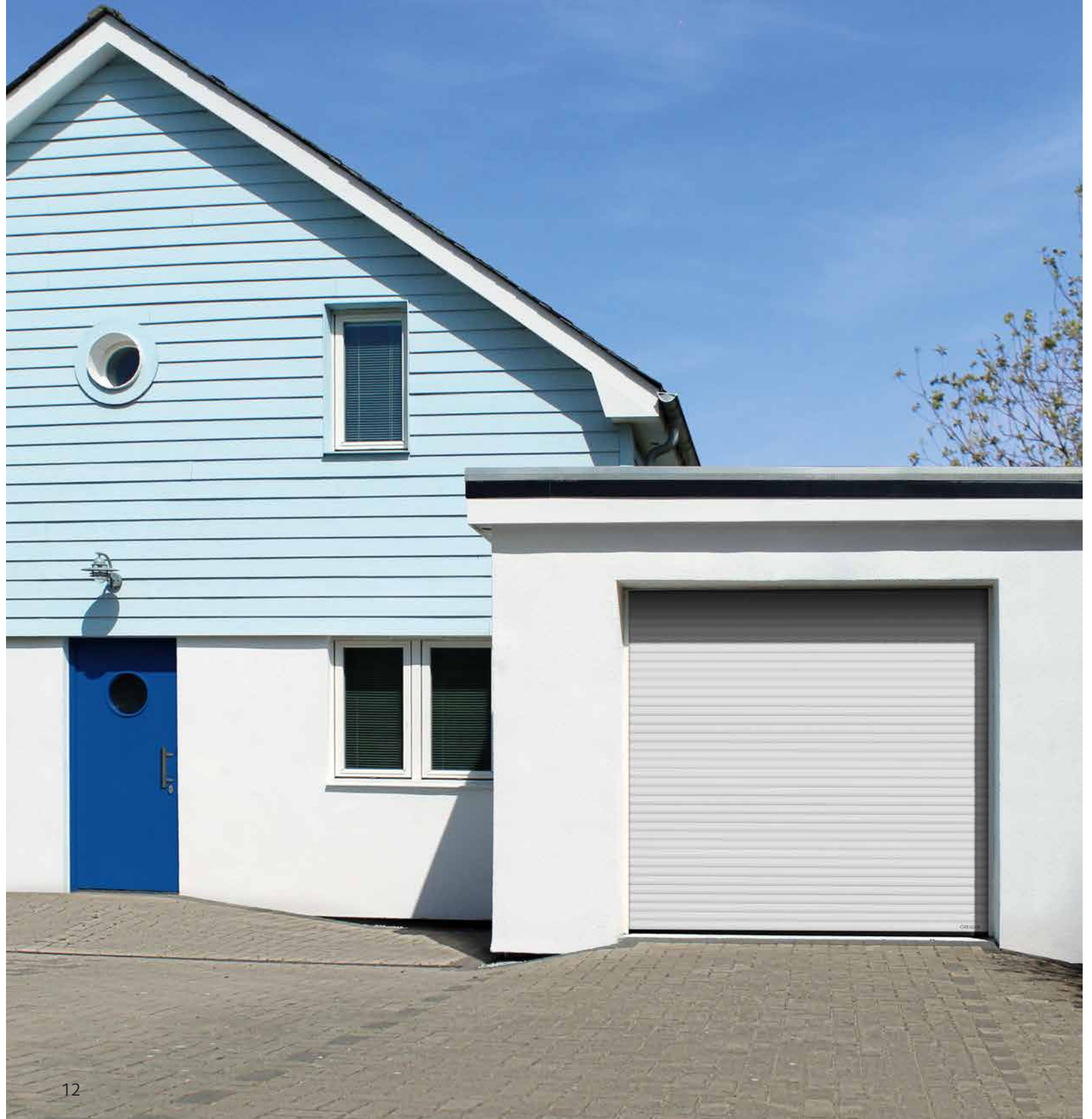

GARADOR *Wired or wireless optical sensor*

## Wired or wireless optical sensor

The GaraGlide is available with either a wired or wireless optical sensor, to recognise when there is an obstruction in the door curtain's downward path and safely stop the door.



### Wired optical sensor

A wired optical-sensor is fitted into the floor seal for safety. In the event of an obstruction to the door curtain coming down, the light beam from the optical sensor is broken, and the door will stop and reverse.



### Wireless optical sensor

A wireless optical sensor is also available, without the spiral cable. The optical sensor is fitted into the floor seal, and when the light beam is broken, the door will stop and reverse. Batteries are required for this device.



## 75 mm or 105 mm guide rails for ease of installation

With 75 mm guide rails for doors up to 3000 mm wide, and 105 mm guide rails for doors over 3000 mm wide, the GaraGlide is also suitable to install in particularly narrow fitting conditions. Furthermore, a pre-assembled box cover system and a design which requires as little as 4 fixings either side and 4 along the top, means the GaraGlide is quick and easy to install.



## Additional options for GaraGlide



### Additional fascia panel

Stabilizes the main fascia panel, when fitting the door between or behind the opening. Provides a neat appearance, accompanying the lintel without any unattractive fitting holes and is colour matched to the door. Additional fascia panel is always required when fitting between opening and when 100 mm of top fascia panel is showing when fitting behind opening.



### External emergency release

An optional external crank handle means you can open the door using the crank handle from the outside. The external crank handle is attached to an opening, that is lockable with a locking cylinder for security. The door can also be operated from the inside via internal linkage. Please note, the external emergency release cannot be retro-fitted. It must be ordered with the door.



### Manual or electronic limit setting

Specify your GaraGlide with either a manual or electronic limit setting. The manual limit setting (shown left) is established by using the wand to adjust the door opening and closing parameters. An electronic limit setting is programmed through the control panel, for a quick and easy setup.



### Standard 2-button hand transmitter

Standard 433 MHz radio system available as an option. Door is supplied with two 2-button remote hand transmitters.

Please note: standard radio technology cannot be retro-fitted and must be supplied at time of purchase.



## GaraRoll roller doors Expert engineering for a superior design

The GaraRoll is electrically automated with a chain driven operator and unique spring balanced system, minimising strain on the motor and ensuring a long service life. As the operator incorporates force limitation technology (pressure sensitivity), it automatically recognises obstructions and safely reverses, making an additional closing edge safety device unnecessary.

The door curtain lifts vertically and rolls into a compact box at the head of the opening, leaving the ceiling area free for additional storage or lighting. This space-saving design is also ideal for shorter driveways, as there is no "swing out" allowing for much closer parking to the garage door.

Choose from a comprehensive selection of 20 standard colours and made-to-measure door sizes up to 6000 mm wide. The door can be fitted either between or behind the opening, and is also available in an externally fitted design. Comes with a bisecur radio system as standard, for enhanced security.

# GaraRoll



GARADOR *Introducing GaraRoll*

## Chain driven operator design for reliable performance

The GaraRoll utilises a chain driven operator, which does not limit the number of cycles in a residential application and is engineered to deliver a long service life. As the motor incorporates force limitation technology, the GaraRoll does not require an additional closing edge safety device. The operator unit is fitted outside of the box cover for trouble-free maintenance. The DuraBelt anti-scratch system is included as standard.



## Electrically operated with 2 bisecur hand transmitters

Supplied with two 4-button bisecur hand transmitters as standard. Bisecur radio signal encryption protocol makes the system even more secure and ensures a more reliable signal and extended range. The control panel has a separate housing with control buttons and integrated LED light, providing a quick and convenient way to operate the roller door from inside the garage. The GaraRoll can also be operated via the BlueSecur smartphone app.



GARADOR Precision engineered for reliability and longevity

# Precision engineered for reliability and longevity



GARADOR Precision engineered for reliability and longevity



### Space-saving design

The door curtain is constructed from foam-filled aluminium laths, that lift vertically and then roll into a box at the head of the garage door opening, offering a compact solution for home owners that want to retain access to the ceiling space from inside their garage.



### Emergency release in case of power cut

In the event of a power cut, simply pull the cord on the operator unit. This disengages the chain driven motor, allowing you to raise and lower the garage door curtain by hand, and because the door curtain is spring assisted it opens and closes with ease.



### Spring assisted for safety and longevity

Double tension springs and double lifting cables prevent the door from crashing down in the event of a spring or cable failure. The tension springs complement the force limitation of the operator, making an additional closing edge safety device like an opto-sensor unnecessary.



### Soft start and stop

The soft start and soft stop on the GaraRoll's operator, delivers a very smooth and even performance, as well as contributing to a long service life.



GARADOR Precision engineered for reliability and longevity



### Durable weather seals

A sturdy rubber seal at the bottom of the door, keeps unwanted dust and dirt outside. Brush seals in the guide rails, on the inner and outer edge, further enhance the sealing of the door and help to eliminate drafts through the garage.



### Mechanical stop for security

There is a mechanical stop between the top lath and barrel, providing extra security by preventing the door from being lifted.



### Automatic safety reversal

The GaraRoll is the only spring-assisted roller door which uses pressure sensitivity built into the operator to recognise when there is an obstruction in the doors path. So the moment it encounters an obstacle, it immediately stops and reverses.



### Windlocks for protection

Windlocks secure the door curtain in the guide rails, preventing it from popped out in adverse weather conditions with high winds. They also offer increased security, protecting the side of the lath from tampering by a burglar.

## Additional options for GaraRoll

### Additional fascia panel

The additional fascia panel stabilises the fascia panel when fitting in the opening and harmoniously covers the lintel without any unattractive fitting holes. The additional fascia panel is available in the colour of the door or with a Decograin surface.



### The emergency battery

With this emergency power supply, you can bypass network power failures for up to 18 hours and max. 5 door cycles. The emergency battery recharges itself during normal operation.



### Chamfered bottom profile

An aluminium chamfered bottom weather seal compensates for differences in height over the entire door width of up to 300 mm. The profile can be fitted without any difficulty and is simply screwed onto the inserted curtain. The bottom profile is delivered powder-coated in Jet black (similar to RAL 9005). On request, the bottom profile (as shown) is also available in a colour matching the door.



GARADOR Additional options for GaraRoll roller garage door



### Option of manual operation

If required, our GaraRoll is available to order as a manually operated roller door. Unlike other roller doors using a cumbersome hand crank, you can operate the GaraRoll by hand with almost no effort as the counter-balanced springs support the opening and closing cycles of the door.

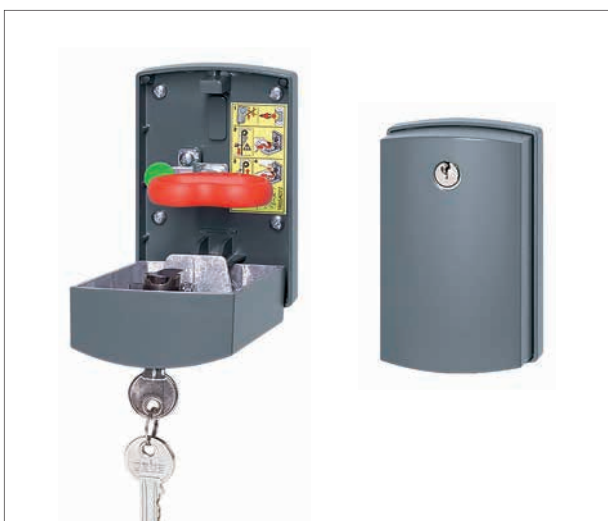

### Exterior door release

The optional exterior door release is recommended when you do not have a second entrance to your garage. It allows you to operate the door manually from the outside in case of a power failure.



### Audible intrusion alarm

The optional audible intrusion alarm with a sound of 110 db can be fitted to offer additional peace of mind.

## DuraBelt anti-scratch system **NEW**

A build-up of dust and dirt on the surface of the roller door curtain can sometimes result in scratches. To combat this problem, Garador have created the unique DuraBelt anti-scratch system, which is specifically designed to reduce scratches and prolong the life of the door curtain.

DuraBelt has been developed exclusively for the GaraRoll roller door and is supplied as standard.

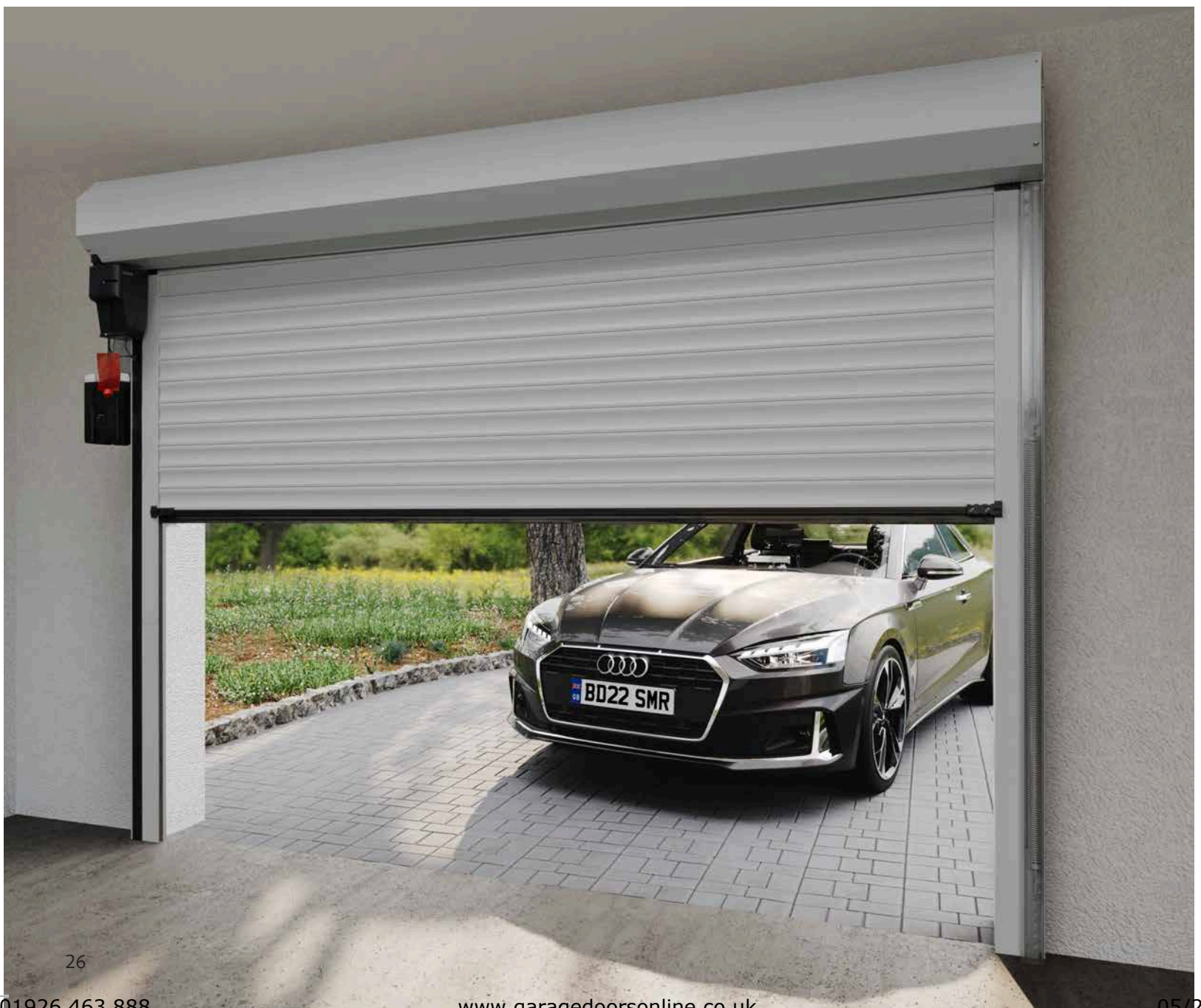

## GARADOR DuraBelt anti-scratch system

**Reduced scratches on door curtain**

The DuraBelt reduces scratches across the surface of the door curtain by up to 98%. It achieves this by providing a protective layer between each lath as they roll up when the door is open.

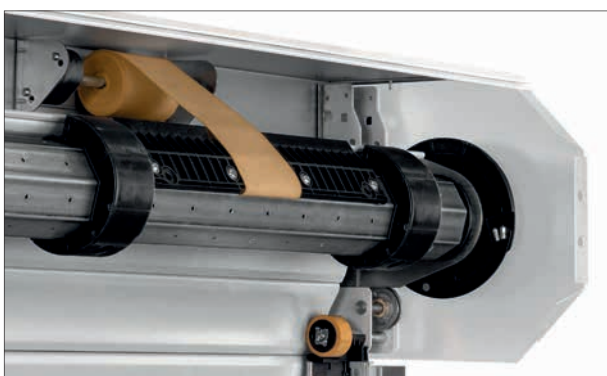
**Durable and long-lasting material**

The belt is made from a microcellular polyurethane elastomer, a material often used in the automotive industry due to its high abrasion resistance and ability to withstand temperature related stress. It does not degrade when exposed to moisture, oil or grease.

**Hidden inside box cover**

All Garador roller doors are supplied with a full box cover for protection. The DuraBelt unit is hidden under the fascia panel and because the material is soft and forgiving, there is less noise when running and no visible marking on the door curtain.

**Exclusive to GaraRoll roller doors**

The unique DuraBelt system has been designed exclusively for GaraRoll roller doors. This system is compact and is not available for retro-fitting to existing Garador roller door installations.

## Colour options

The full range of color options and timber effect finishes are available to choose for either the GaraRoll or GaraGlide roller garage doors.

### 16 STANDARD COLOUR FINISHES

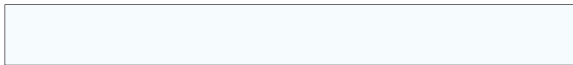

Traffic White (RAL 9016)



Grey Aluminium (RAL 9007)



White Aluminium (RAL 9006)

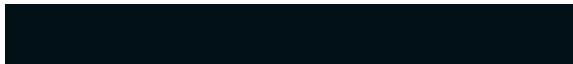

Jet Black (RAL 9005)



Cream (RAL 9001)



Terra Brown (RAL 8028)



Light Grey (RAL 7035)



Anthracite Grey (RAL 7016)



Slate Grey (RAL 7015)



Moss Green (RAL 6005)



Steel Blue (RAL 5011)



Ruby Red (RAL 3003)



Purple Red (RAL 3004)



Light Ivory (RAL 1015)



Chartwell Green



Anthracite Metallic (Noir 2100 Sable)\*

### 2 TIMBER-EFFECT FINISHES (FOIL COAT)



Golden Oak (timber effect)



Rosewood (timber effect)

### 2 TIMBER-EFFECT FINISHES (DECO PAINT)



Golden Oak (timber effect)



Rosewood (timber effect)

Printed colour samples are as accurate as printing techniques allow.

\* Please note, Anthracite Metallic (Noir 2100 Sable) is classed as a special colour for GaraGlide roller doors.





## Profile options

The aluminium profiles of our roller garage doors are filled with a CFC-free polyurethane foam which provides a good thermal insulation to enhance energy savings and contributes to a quiet door action. Available for GaraRoll and GaraGlide.

### Profile with thermal insulation

The aluminium profiles are 77 mm high and are filled with polyurethane rigid foam for strength and a quiet door travel.



### Window

Add a window for an individual design and the use of daylight in your garage.

The number of elements depends on the respective door width. A maximum of ten profiles can be fitted with glazings in each door.



### Ventilation grilles

Ventilation of your garage improves the room climate and prevents mould.

A maximum of ten profiles can be used for each door.



## Control your garage door with your smartphone

We use our smartphones everyday to talk, type messages and browse the internet. With Garador's new BlueSecur app, you can quickly and conveniently operate your GaraRoll roller door using your smartphone too. An integrated bluetooth receiver provides a secure, reliable connection. The bluetooth receiver can be turned on or off.

Our range of genuine GaraRoll operator accessories, such as hand transmitters, code switches and wall consoles, are still available for a more traditional control device.

### Garador BlueSecur App

- Control your GaraRoll roller door (open/ close/ open partially/ light) from your smartohone.
- Quick and easy-to-use interface.
- Push notifications when receivers come into range.
- Free download from App store or Google Play.
- One free user key included. Others available via in-app purchase.

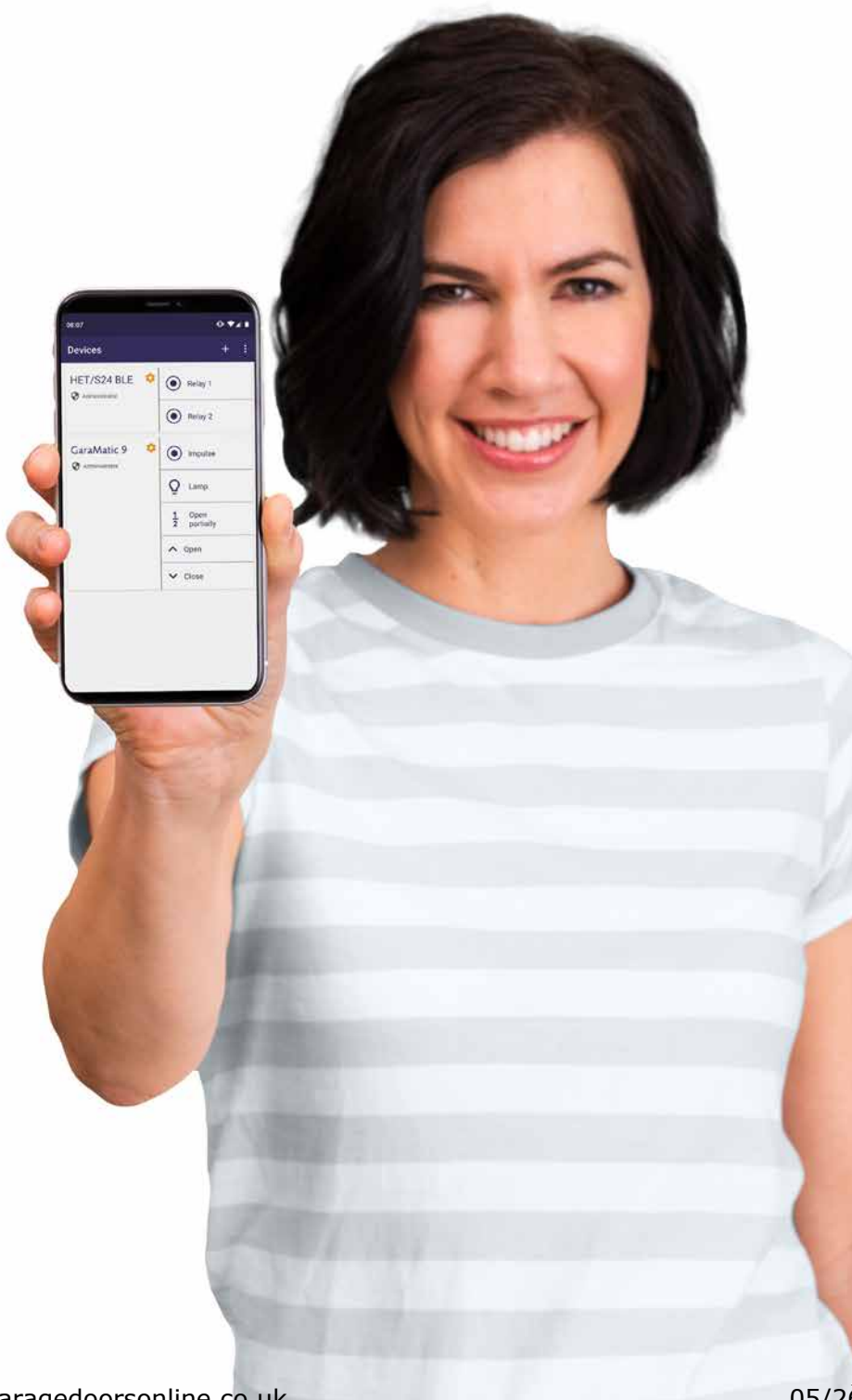

## GaraRoll operator accessories



### 5 button Bi-directional hand transmitter

4 Control buttons, plus a status function.  
Available in matt black texture, high-gloss black or white.



### 2 button Bi-directional hand transmitter

Features 2 control buttons and an eyelet for a key ring. Available in high-gloss black or white, green and wood effect.



### 4 button Bi-directional hand transmitter

4 Control Buttons.  
Available in matt black texture with chrome or black end caps.

Features 4 control buttons and an eyelet for a key ring. The 4 button hand transmitter can be programmed to open up to four garage doors.



### 1 or 4 button Bi-directional hand transmitter

1 or 4 Control Buttons.  
Available in high-gloss black.

The 1 button hand transmitter combines convenience and style with the simplicity of a single button to operate your garage door.

The 4 button hand transmitter can be programmed to open up to four garage doors.



### Hand transmitter station

Available in high-gloss black and white.

The hand transmitter station provides a handy and stable solution for storing your 5 button, 4 button or 1 button remote hand transmitter when it is not in use.

## GaraRoll operator accessories



### Robust 3-button hand transmitter

Robust and weather resistant design with 3 control buttons. Available in black.

Rubber coated surface with 3 large buttons. Easy to operate, even when wearing gloves after gardening or riding a bicycle. Features eyelet, lanyard and belt clip so its there when you need it.



### Transmitter for cigarette lighter

1-channel (fig. left)  
2-channel (fig. right)

One or two key functions. For insertion into Car cigarette lighter. Battery operated.

In car transmitter plugs directly into your car cigarette lighter and can be programmed to open up to two garage doors.



### Radio code switch FCT 3 BS

For 3 functions. With illuminated buttons.

Surface mounted fitting possible, plastic housing in Light Grey (RAL 7040)



### Radio code switch FCT 10 BS

For 10 functions With illuminated buttons and hinged cover.

Surface mounted fitting possible, plastic housing in Light Grey (RAL 7040). Hinge cover painted in White Aluminium (RAL 9006).



### Wired wall console IT3 B

3 functions Supplied with 7 metre connecting lead (2 wires)

Button for opening and closing garage door. Plus additional buttons for light (on/ off) and operator (on/off). Painted in Pure White (RAL 9010).



### Wireless wall console FIT 2 BS

3 button functions

Two push buttons for controlling up to 2 garage doors, via radio signal. One additional button for on/off function of connected external elements. Painted in Pure White (RAL 9010).



### Internal push button IT 1b-1

Large, illuminated button for convenient opening of the door.

Plastic housing in Pure white (RAL 9010).

# View the full range of Garador garage doors

All Garador garage doors have been developed with reliability, safety and security in mind. We offer an extensive choice of up & over, side hinged, sectional and roller garage doors, each engineered with a different design so you are sure to find the right solution for your home. To find the right garage door for your home, please ask for the full Garador brochure range.

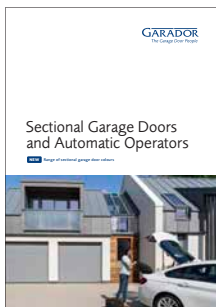

# GARADOR

*The Garage Door People*

Bunford Lane, Yeovil, Somerset, BA20 2EJ  
Tel: (01935) 443722 Fax: (01935) 443744



Garador is the UK's leading manufacturer of garage doors and operators, with an ultra-modern production facility located in Somerset. We use German engineering expertise to produce highly sophisticated doors and operators. By purchasing a Garador product you can be assured of the highest level of quality, safety and security. With a nationwide network of stockists, installers and service technicians we are an ideal partner for your project.