



# Roller Garage Door / Rolling Grille RollMatic

Roller garage door RollMatic IR/AR, rolling grille RollMatic,  
overhead garage door RollMatic OD, rolling grille HG75TD, side door NT 60

Technical Manual  
Issue 01.07.2018

**HÖRMANN**

# Contents

Contents	Page
<b>Roller garage door / rolling grille RollMatic</b>	
Size range roller garage door RollMatic	03
Size range rolling grille RollMatic door curtain HG 75	04
Size range rolling grille RollMatic door curtain HG-L	05
Fitting types roller garage door RollMatic	06 – 08
Fitting types rolling grille RollMatic	09 – 11
Chamfered bottom profile roller garage door/rolling grille RollMatic	12
Fixing points roller garage door RollMatic	13 – 15
Fixing points rolling grille RollMatic	16 – 19
Connections for Control and Emergency Release	20
<b>Overhead garage door RollMatic OD</b>	
Size range RollMatic OD	21
Fitting Types	22 – 24
Fixing Points	25 – 27
Vertical track fastening and distance back	28
<b>Rolling grille HG 75 TD</b>	
Size range rolling grille HG 75 TD	29
Fitting Types	30 – 32
Fixing Points	33 – 35
Electrical Connections	36
<b>Side door NT 60, profile type 4</b>	
Side door NT 60 with corner frame made of aluminium profiles	37 – 39
Side door NT 60 with block frame made of aluminium profiles	40 – 44

Door leaf constructions and track applications as well as fitting examples are provided in this manual.

The door opening and garage floor must be finished before fitting the garage doors.

No part may be reproduced without our prior permission.

All rights reserved.

All dimensions in mm.

Subject to design changes.

# Roller Garage Door RollMatic

Internal (IR) and external roller garage door (AR)

## Viewed from outside

### Door curtain

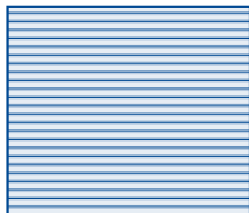

**Notes:**  
Manually operated version only possible with internal roller garage door

## Size range

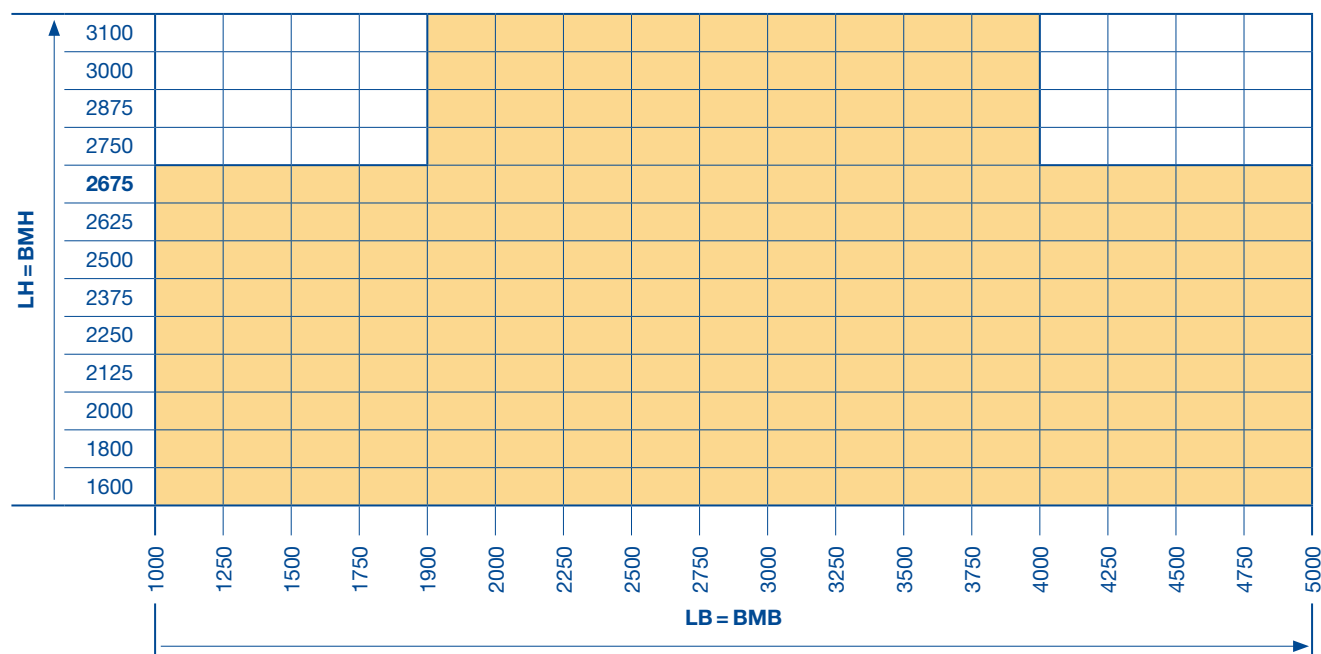

 RollMatic

**BMB** Ordering size width  
**BMH** Ordering size height  
**LB** Clear width  
**LH** Clear height

# Rolling Grille RollMatic

## Door curtain HG 75

### Viewed from outside

Door curtain HG 75, straight

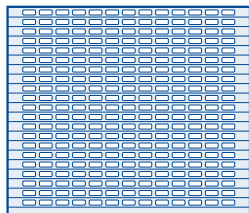

Door curtain HG 75, offset

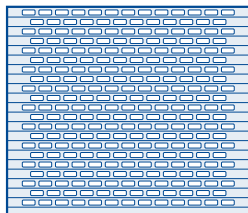

### Size range

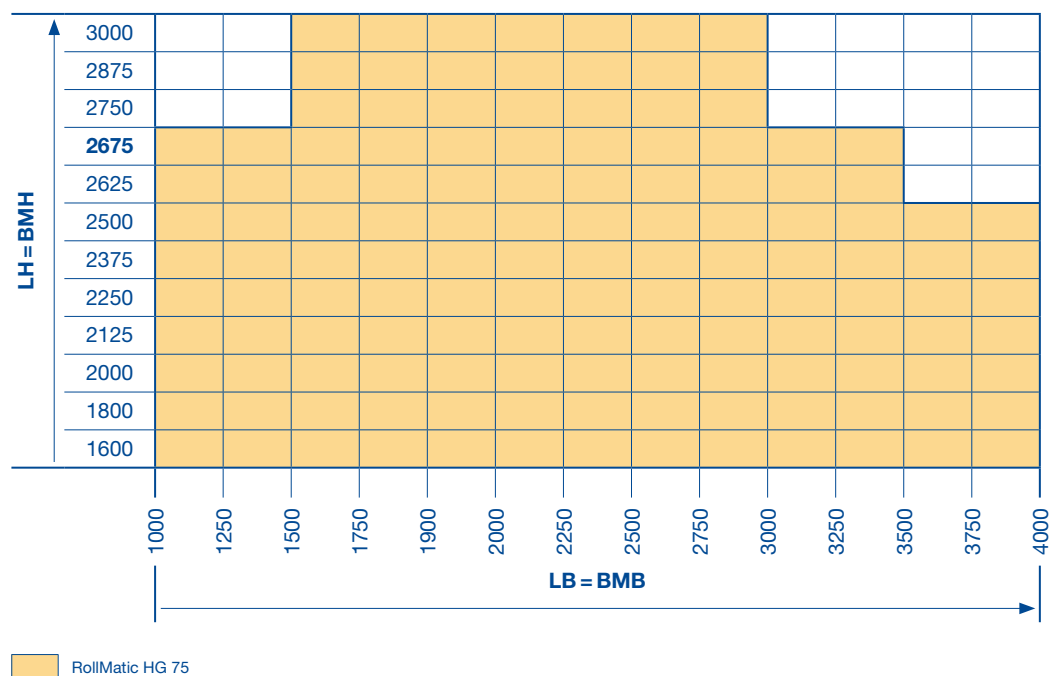

RollMatic HG 75

- BMB** Ordering size width
- BMH** Ordering size height
- LB** Clear width
- LH** Clear height

# Rolling Grille RollMatic

## Door curtain HG-L

Viewed from outside

Door curtain HG-L

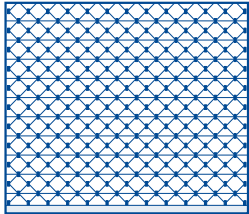

Size range

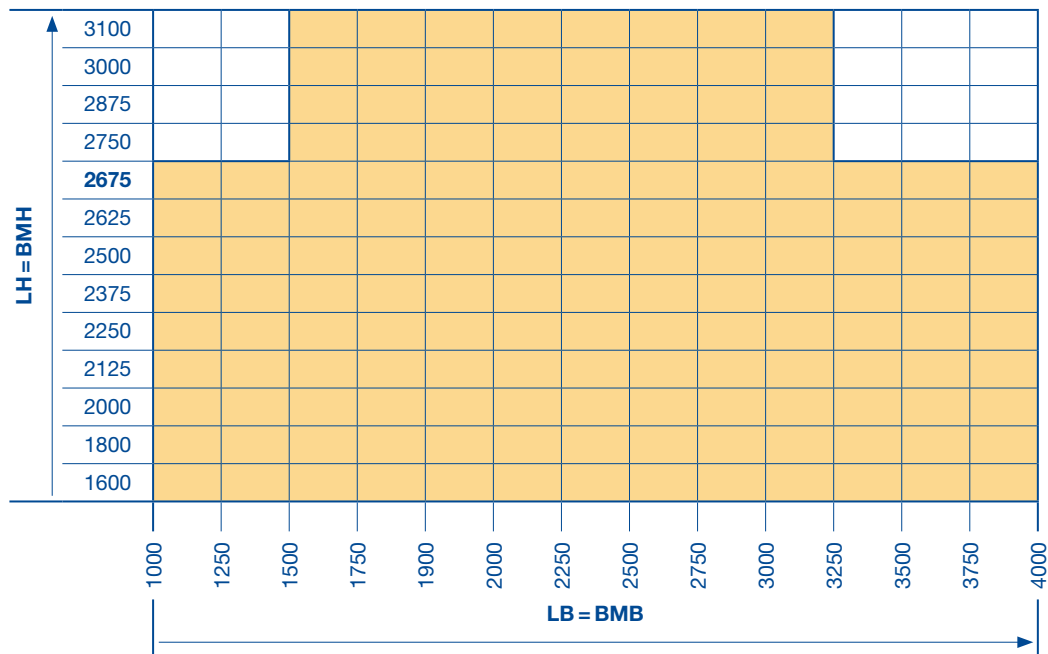

 RollMatic HG-L

**BMB** Ordering size width  
**BMH** Ordering size height  
**LB** Clear width  
**LH** Clear height

# Fitting Types

## Internal roller garage door RollMatic

### Fitting behind the opening

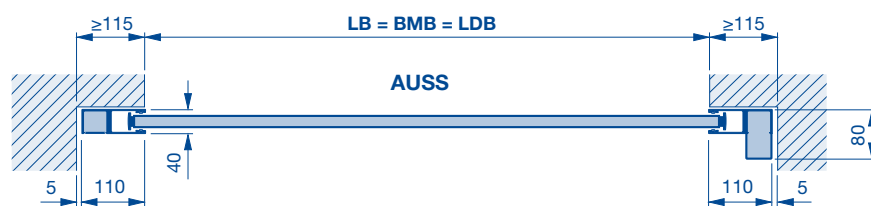
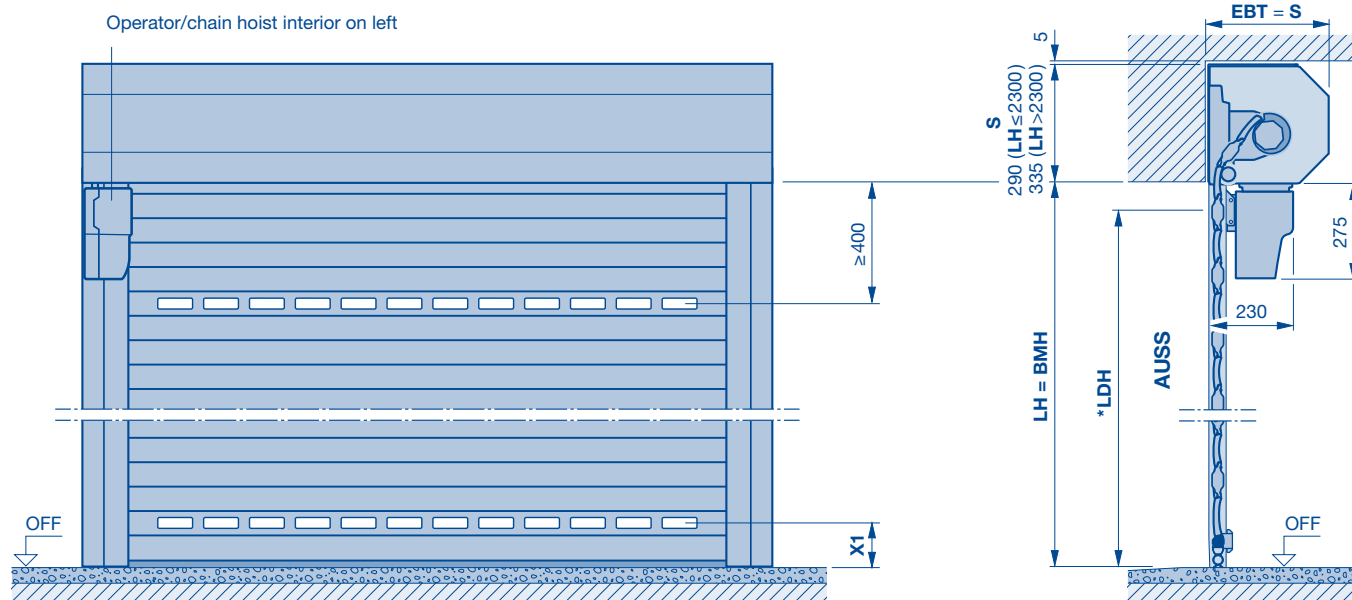

	Version with operator RollMatic	Manually operated version
* Clear passage height (LDH)	LH - 60	LH - 125

**AUSS** Exterior  
**BMB** Ordering size width  
**BMH** Ordering size height  
**EBT** Fitting depth

**LB** Clear width  
**LDB** Clear passage width  
**LH** Clear height  
**LDH** Clear passage height

**S** Required headroom  
**X1** At least 150 mm (dimension without chamfered bottom profile)  
**OFF** Finished floor level

# Fitting Types

## Internal roller garage door RollMatic

### Fitting in the opening

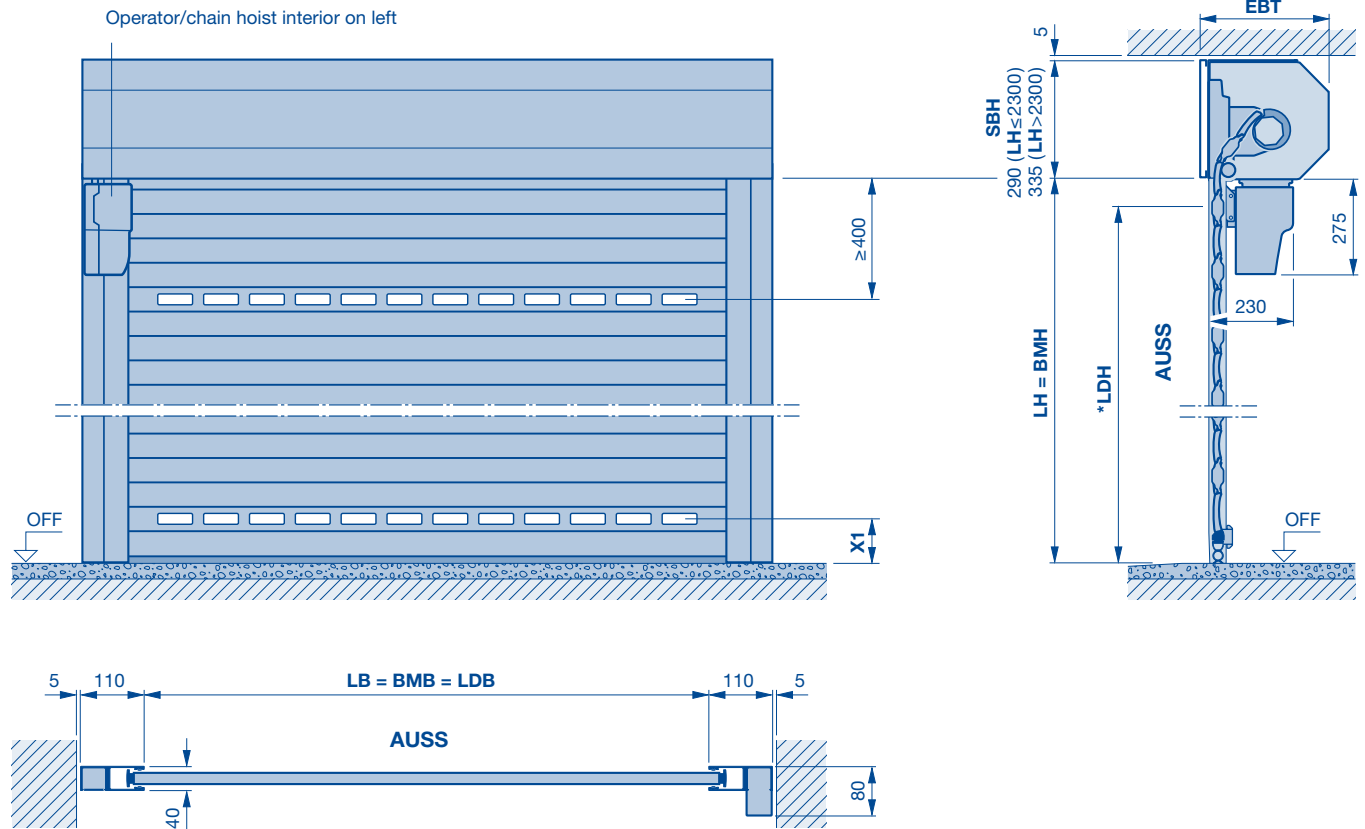

**Note:**

An additional fascia panel is required!

	Version with operator RollMatic	Manually operated version
* Clear passage height (LDH)	LH - 60	LH - 125

<b>AUSS</b>	Exterior	<b>LB</b>	Clear width	<b>SBH</b>	Additional fascia panel height
<b>BMB</b>	Ordering size width	<b>LDB</b>	Clear passage width	<b>X1</b>	At least 150 mm (dimension without chamfered bottom profile)
<b>BMH</b>	Ordering size height	<b>LH</b>	Clear height	<b>OFF</b>	Finished floor level
<b>EBT</b>	Fitting depth	<b>LDH</b>	Clear passage height		

# Fitting Types

## External roller garage door RollMatic

### Fitting in front of the opening

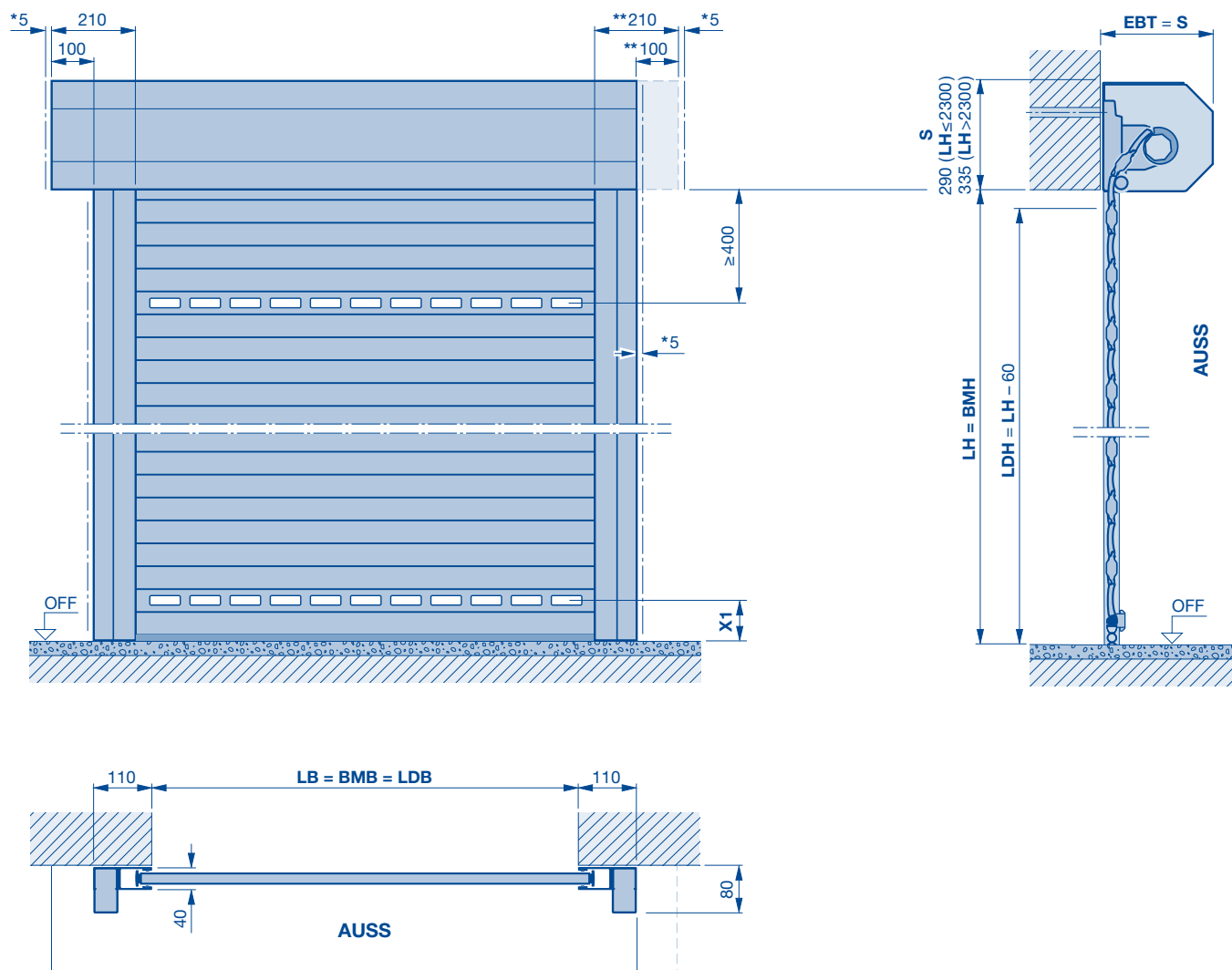

**Note:**

Operator as standard on left when viewed from outside.  
 Operator on right optionally available.

- \* At least 5 mm distance from fascia panel / side guide
- \*\* For a visually balanced look the barrel casing can be ordered symmetrically.

<b>AUSS</b>	Exterior	<b>LB</b>	Clear width	<b>S</b>	Required headroom
<b>BMB</b>	Ordering size width	<b>LDB</b>	Clear passage width	<b>X1</b>	At least 150 mm (dimension without chamfered bottom profile)
<b>BMH</b>	Ordering size height	<b>LH</b>	Clear height	<b>OFF</b>	Finished floor level
<b>EBT</b>	Fitting depth	<b>LDH</b>	Clear passage height		



# Fitting Types

## Rolling Grille RollMatic

### Fitting behind the opening

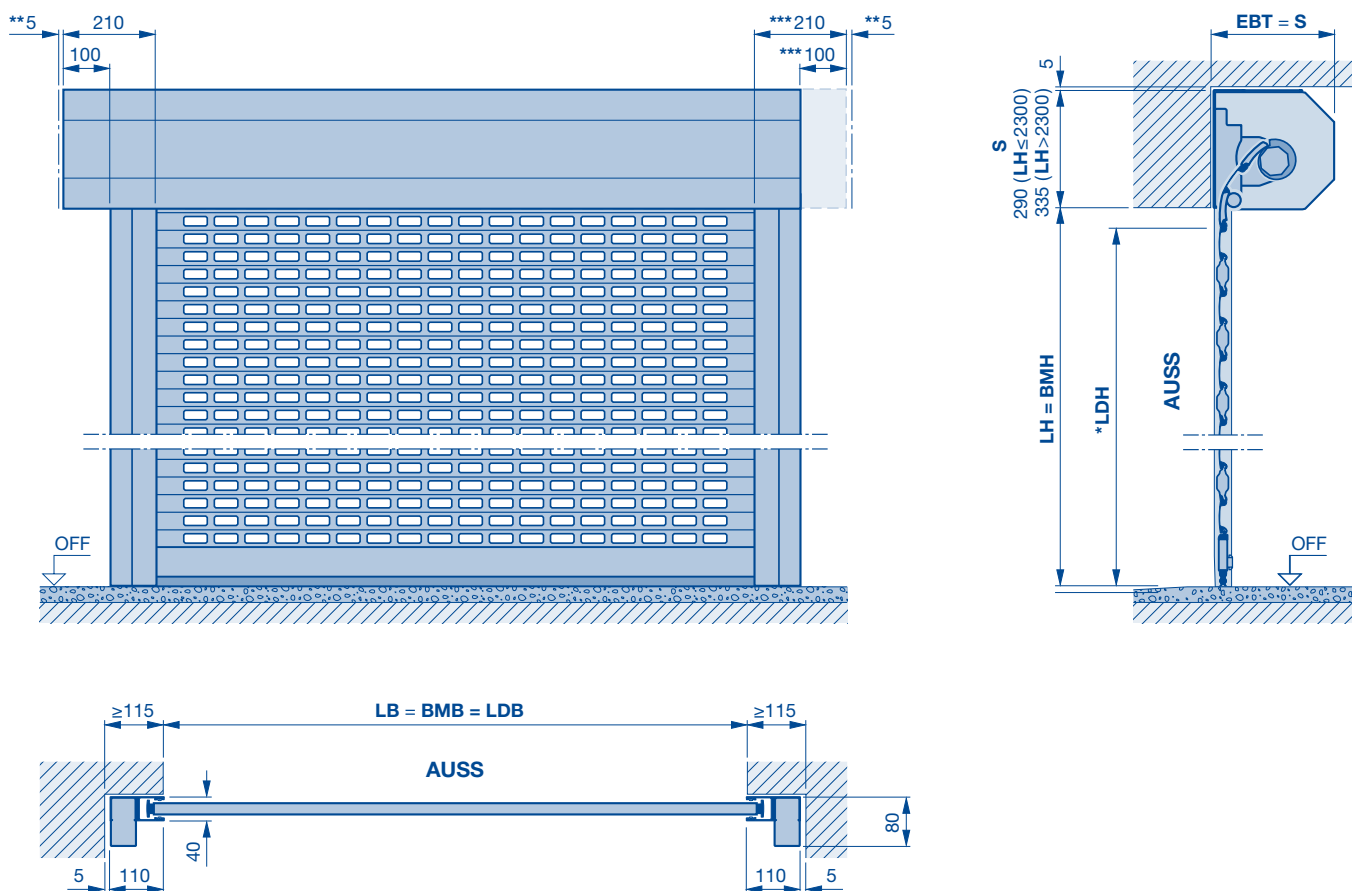

**Note:**  
Operator on left as standard. Operator on right optionally available.

	Version with operator RollMatic	Manually operated version / lockable bottom profile / shootbolt
* Clear passage height (LDH)	LH - 60	LH - 125

\*\* Side distance min. 5 mm  
\*\*\* For a visually balanced look the barrel casing can be ordered symmetrically.

<b>AUSS</b>	Exterior	<b>LB</b>	Clear width	<b>S</b>	Required headroom
<b>BMB</b>	Ordering size width	<b>LDB</b>	Clear passage width	<b>OFF</b>	Finished floor level
<b>BMH</b>	Ordering size height	<b>LH</b>	Clear height		
<b>EBT</b>	Fitting depth	<b>LDH</b>	Clear passage height		

# Fitting Types

## Rolling Grille RollMatic

### Fitting in the opening (only manually operated)

Pull cord viewed from inside, left

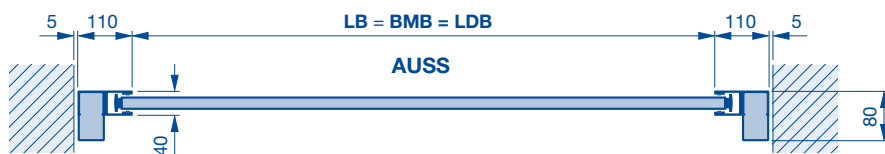
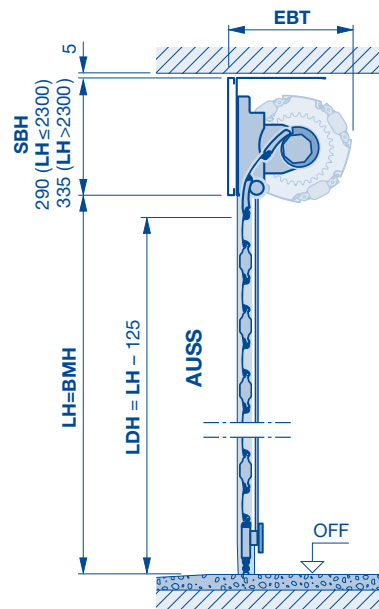
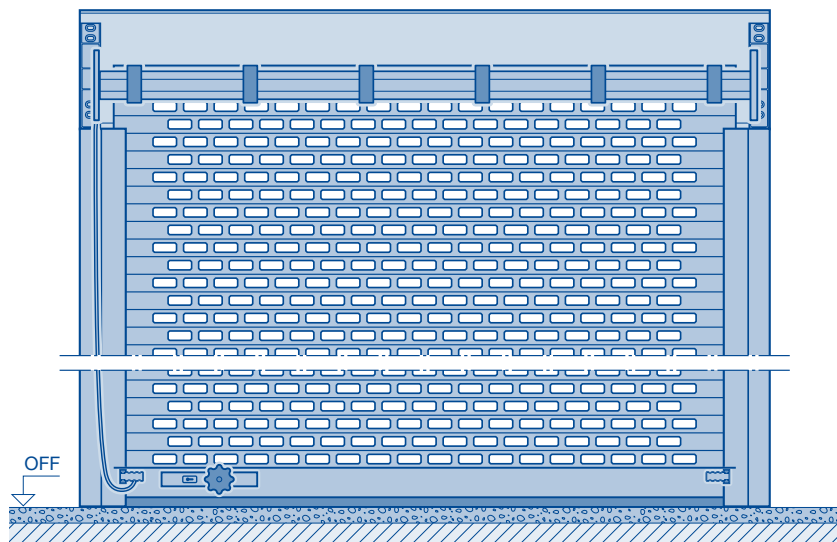

<b>AUSS</b>	Exterior
<b>BMB</b>	Ordering size width
<b>BMH</b>	Ordering size height
<b>EBT</b>	Fitting depth

<b>LB</b>	Clear width
<b>LDB</b>	Clear passage width
<b>LH</b>	Clear height
<b>LDH</b>	Clear passage height

<b>SBH</b>	Additional fascia panel height
<b>OFF</b>	Finished floor level

# Fitting Types

## Rolling Grille RollMatic

### Fitting in front of the opening – external

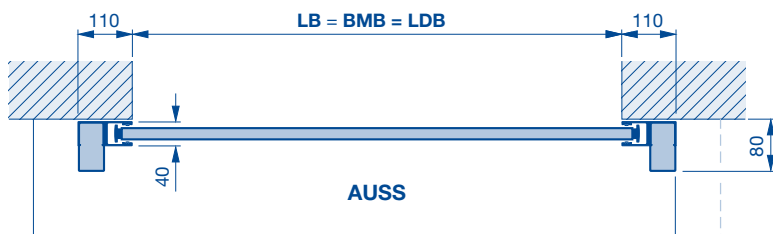
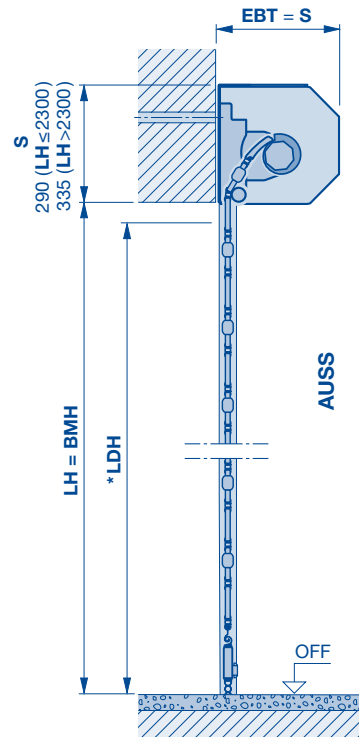
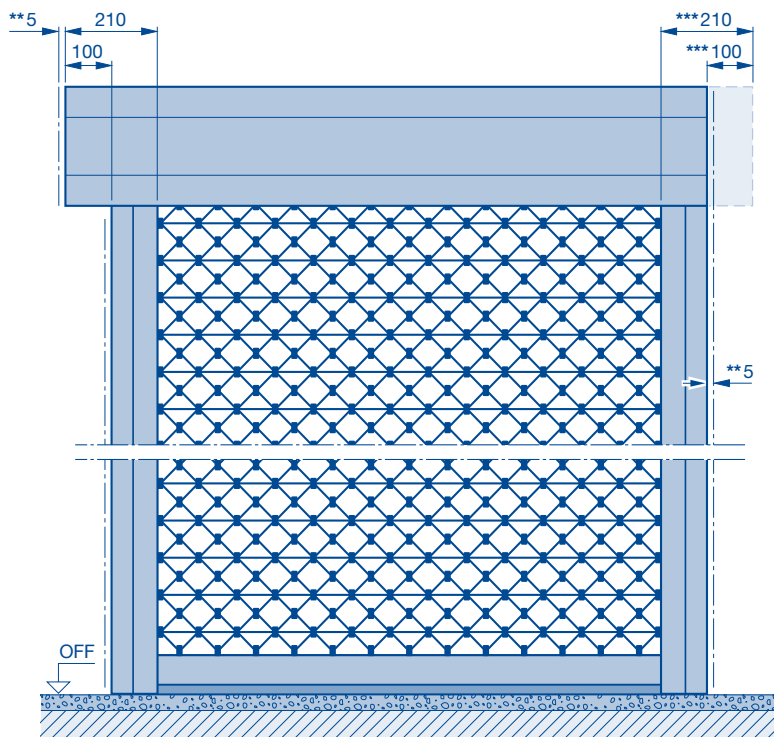

**Note:**

Operator on left as standard. Operator on right optionally available.

	Version with operator RollMatic	Manually operated version / lockable bottom profile / shootbolt
* Clear passage height (LDH)	LH – 60	LH – 125

\*\* Side distance from fascia panel / side guide at least 5 mm.

\*\*\* For a visually balanced look the barrel casing can be ordered symmetrically.

**AUSS** Exterior  
**BMB** Ordering size width  
**BMH** Ordering size height  
**EBT** Fitting depth

**LB** Clear width  
**LDB** Clear passage width  
**LH** Clear height  
**LDH** Clear passage height

**S** Required headroom  
**OFF** Finished floor level

# Chamfered Bottom Profile

## Roller garage door / rolling grille RollMatic

### View of fitting side

- For internal roller garage door, from inside
- For external roller garage door, from outside

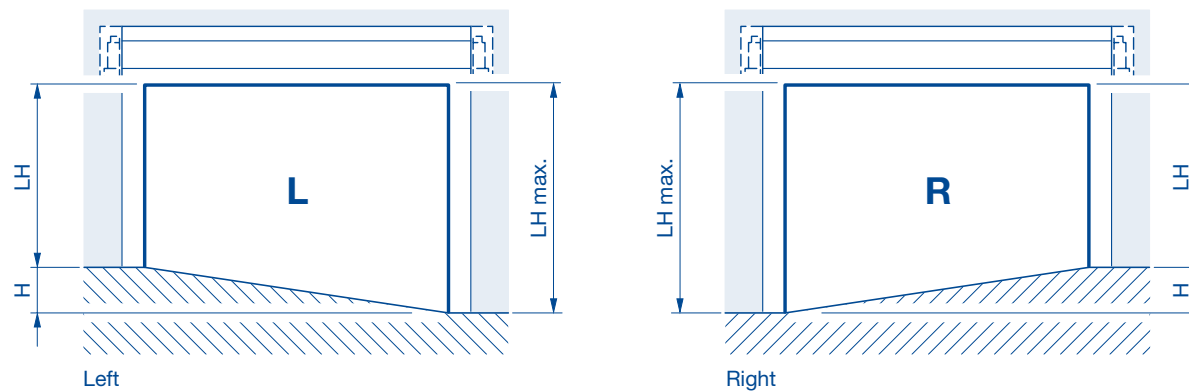

LH = (Clear height on short side) = ordering size height (BMH)

Max. LH = 3100 mm

Min. LH = 1600 mm

H = Height difference max. 300 mm

### Note:

Chamfered bottom profile only for doors with operator!

<b>BMH</b>	Ordering size height
<b>H</b>	Height difference
<b>LH</b>	Clear height

# Fixing Points Internal Roller Garage Door

## Roller Garage Door RollMatic

### Fitting behind the opening

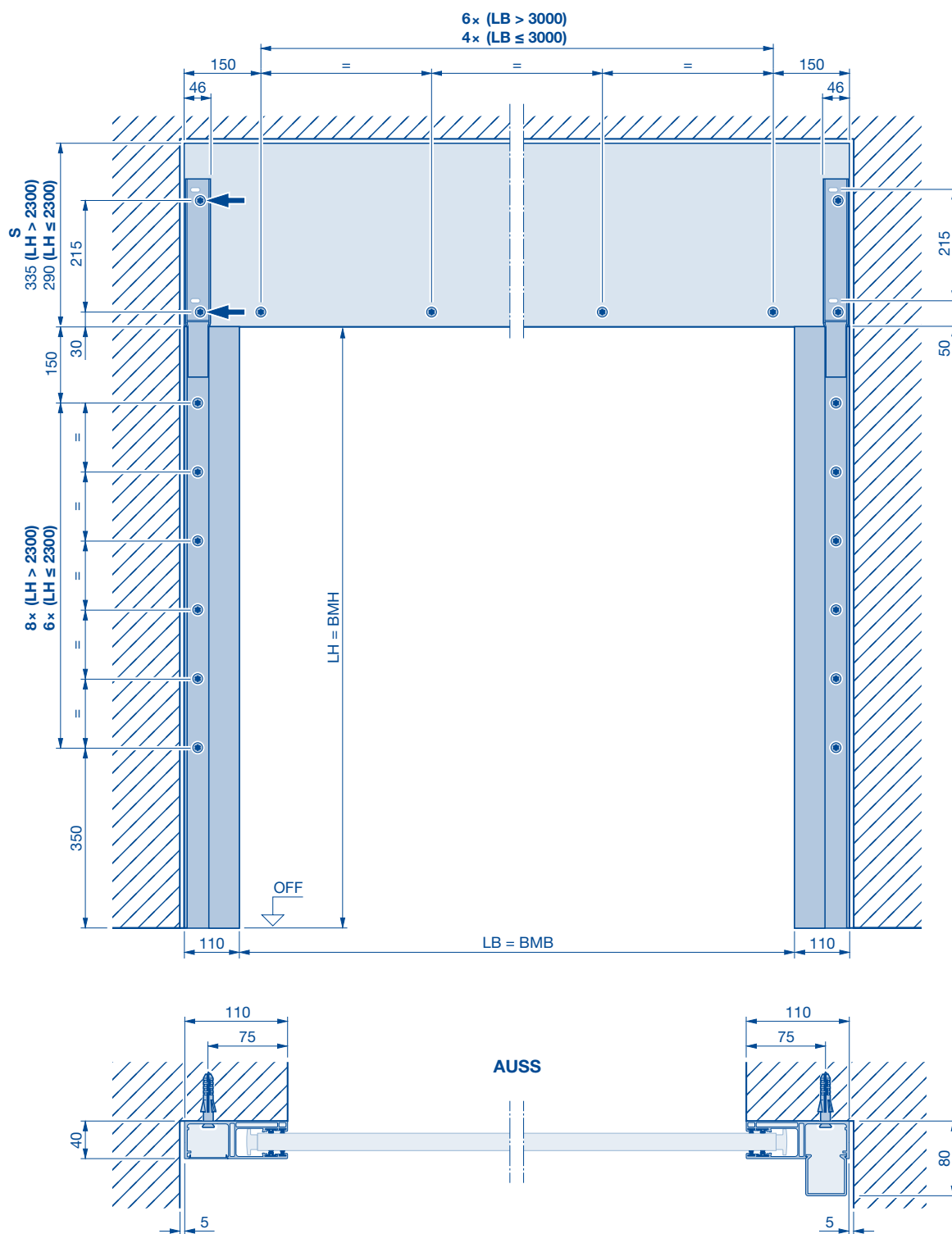

**AUSS** Exterior  
**BMB** Ordering size width  
**BMH** Ordering size height  
**LB** Clear width

**LH** Clear height  
**S** Required headroom  
**OFF** Finished floor level

# Fixing Points Internal Roller Garage Door

## Roller Garage Door RollMatic

Fitting in the opening with additional fascia panel

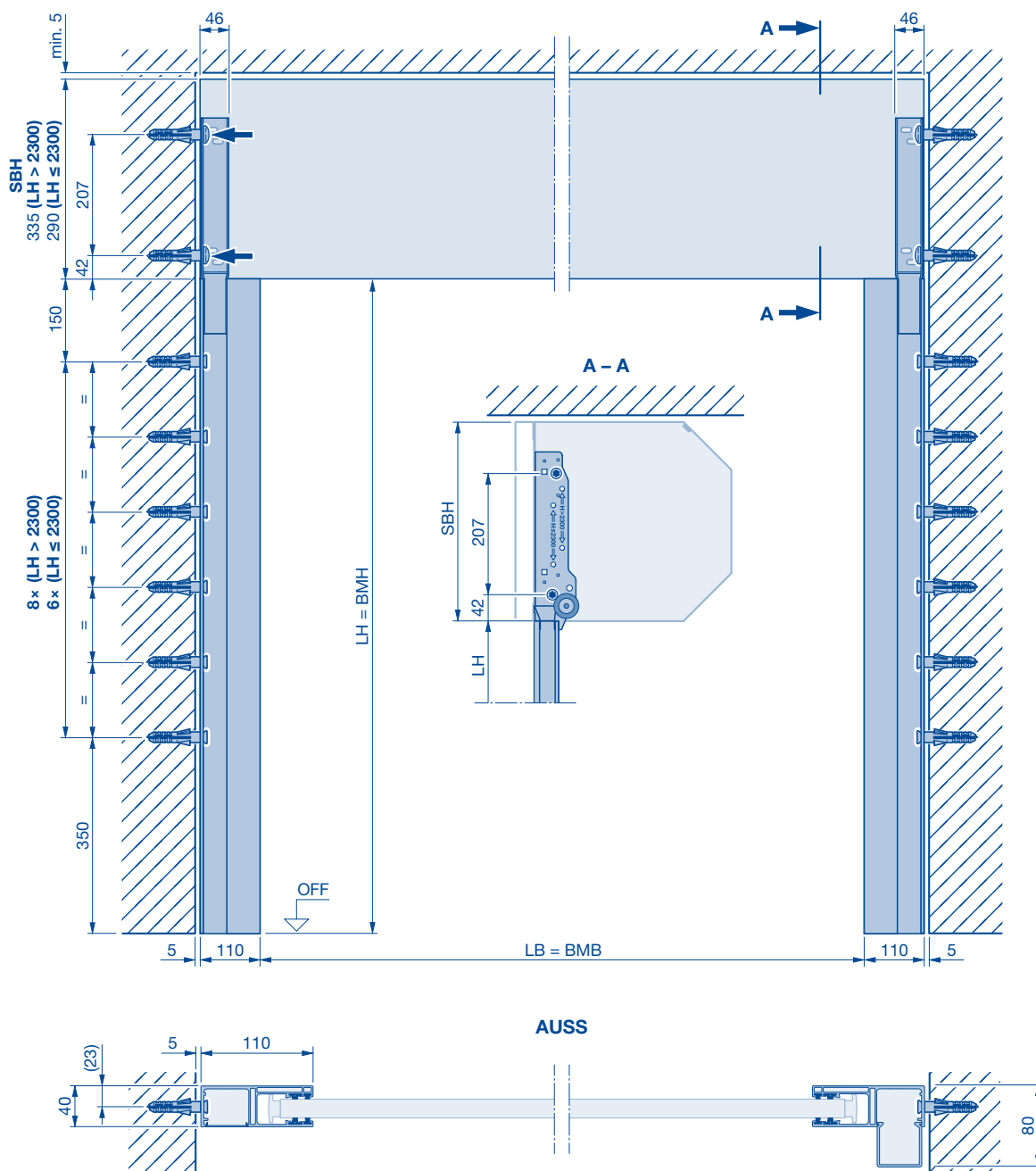

**AUSS** Exterior  
**BMB** Ordering size width  
**BMH** Ordering size height  
**LB** Clear width

**LH** Clear height  
**SBH** Additional fascia panel height  
**OFF** Finished floor level

# Fixing Points External Roller Garage Door

## Roller Garage Door RollMatic

### Fitting in front of the opening

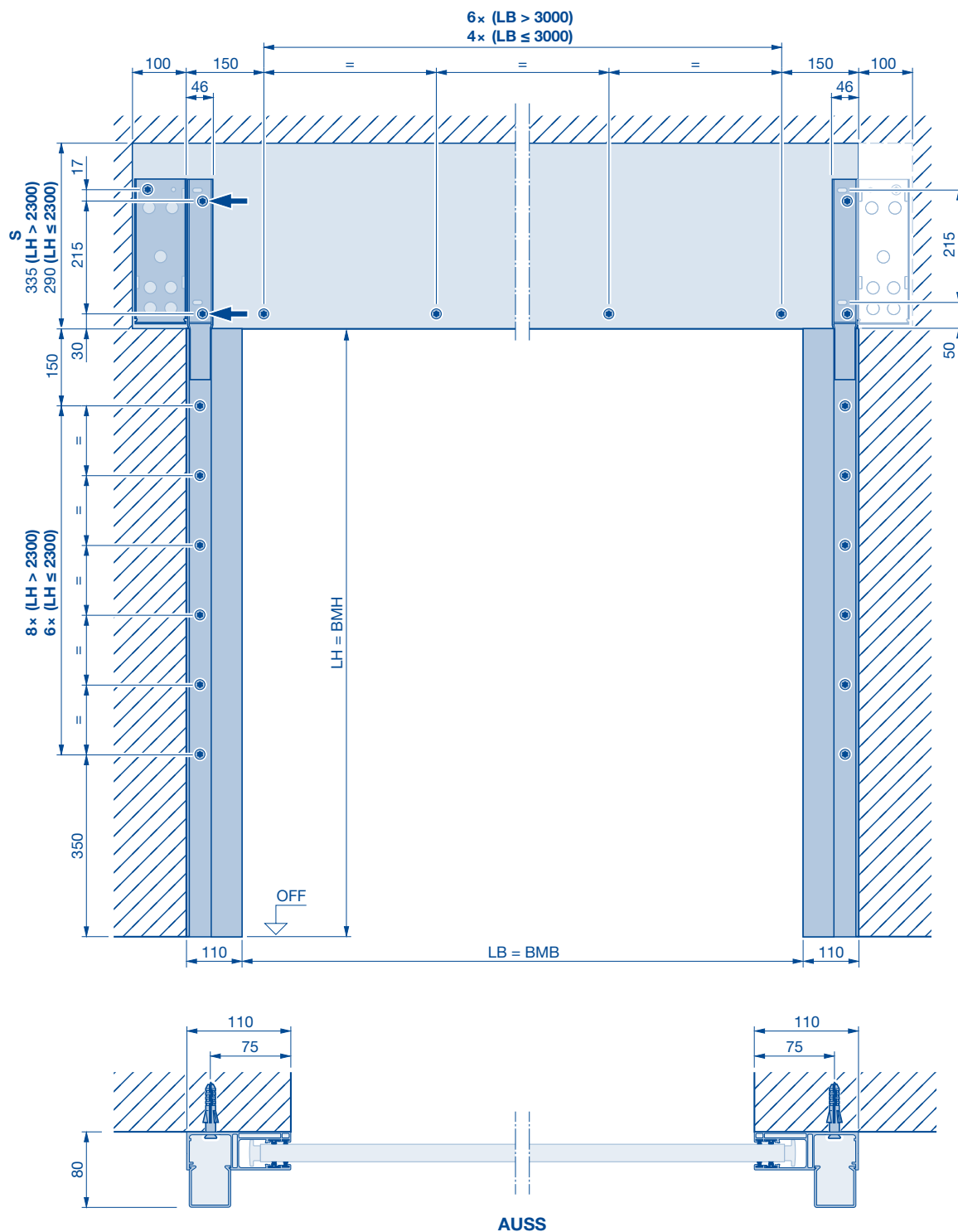

**AUSS** Exterior  
**BMB** Ordering size width  
**BMH** Ordering size height  
**LB** Clear width

**LH** Clear height  
**S** Required headroom  
**OFF** Finished floor level

# Fixing Points

## Rolling Grille RollMatic

### Fitting behind the opening – with operator

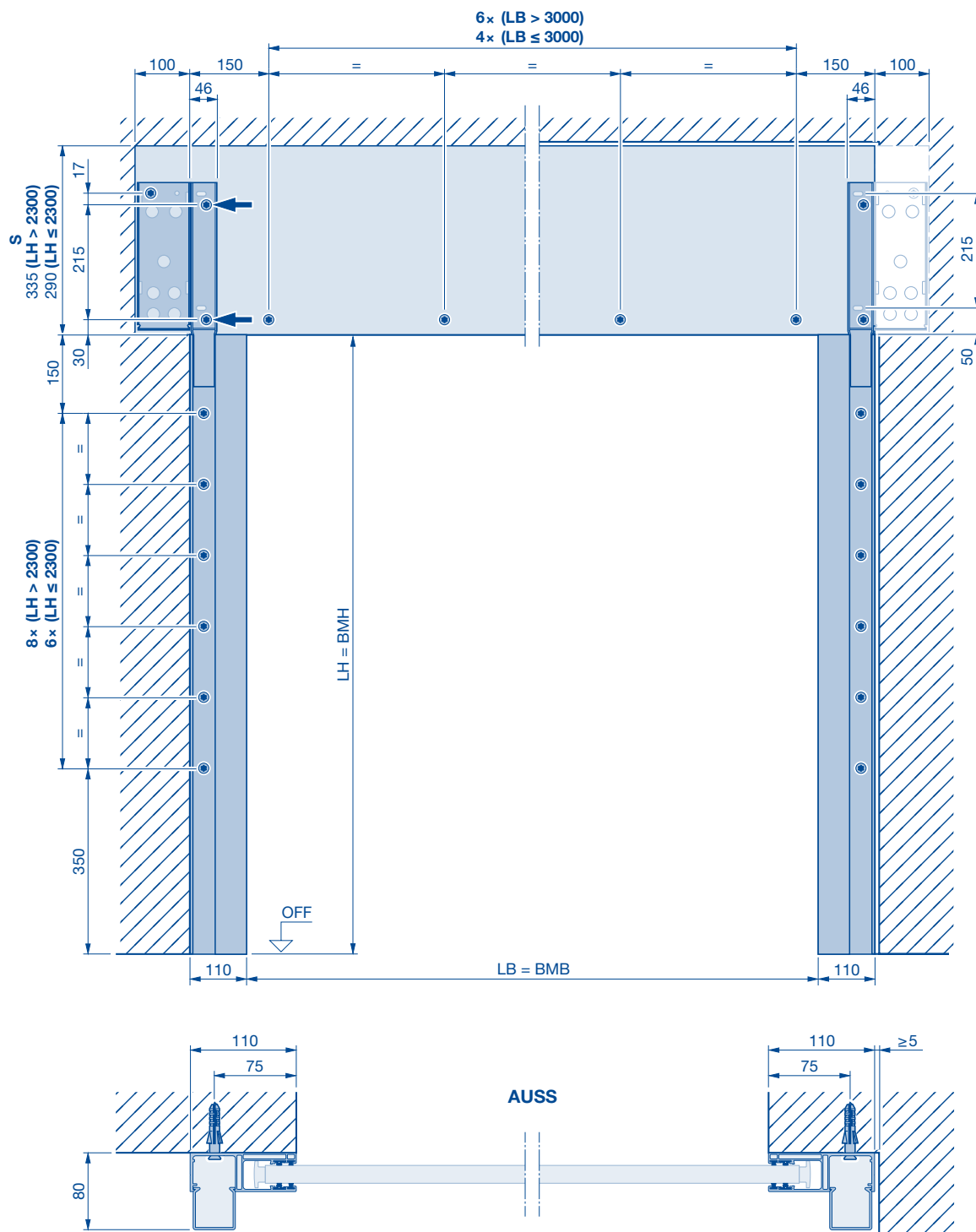

**AUSS** Exterior  
**BMB** Ordering size width  
**BMH** Ordering size height  
**LB** Clear width

**LH** Clear height  
**S** Required headroom  
**OFF** Finished floor level



# Fixing Points

## Rolling Grille RollMatic

**Fitting behind the opening – manually operated version**

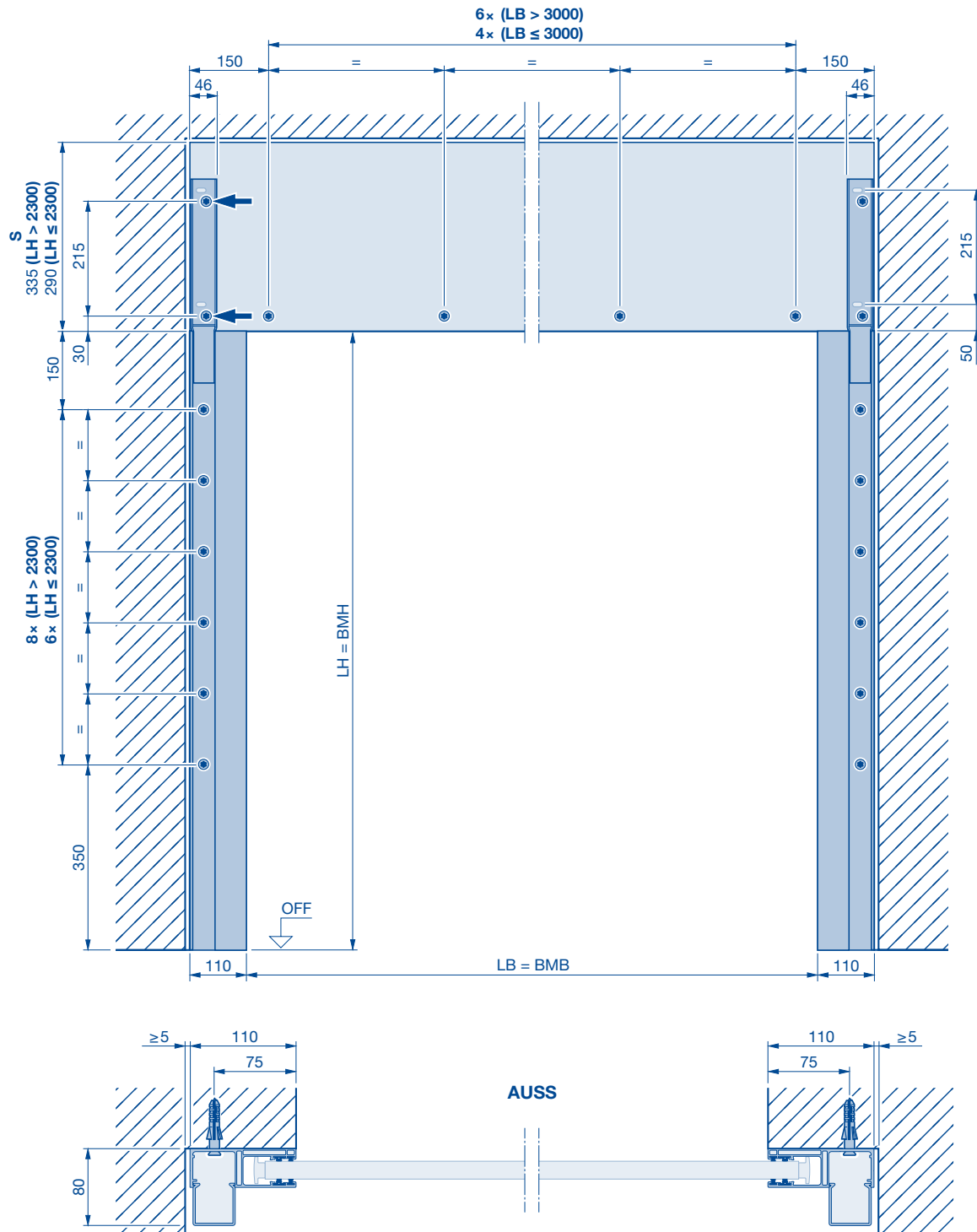

**AUSS** Exterior  
**BMB** Ordering size width  
**BMH** Ordering size height  
**LB** Clear width

**LH** Clear height  
**S** Required headroom  
**OFF** Finished floor level

# Fixing Points

## Rolling Grille RollMatic

Fitting in the opening with additional fascia panel – manually operated version

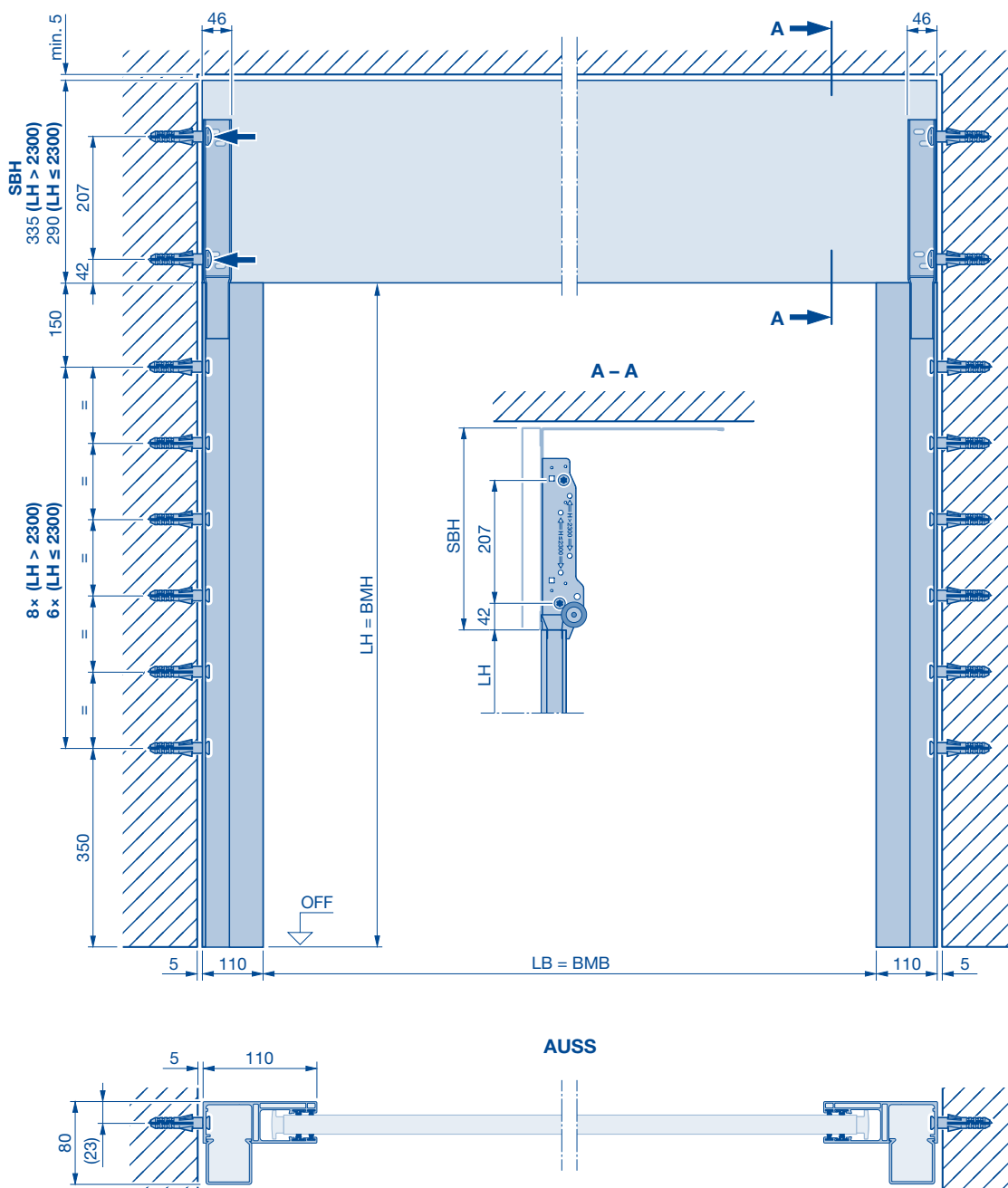

**AUSS** Exterior  
**BMB** Ordering size width  
**BMH** Ordering size height  
**LB** Clear width

**LH** Clear height  
**SBH** Additional fascia panel height  
**OFF** Finished floor level

# Fixing Points

## Rolling Grille RollMatic

Fitting in front of the opening – external – with operator

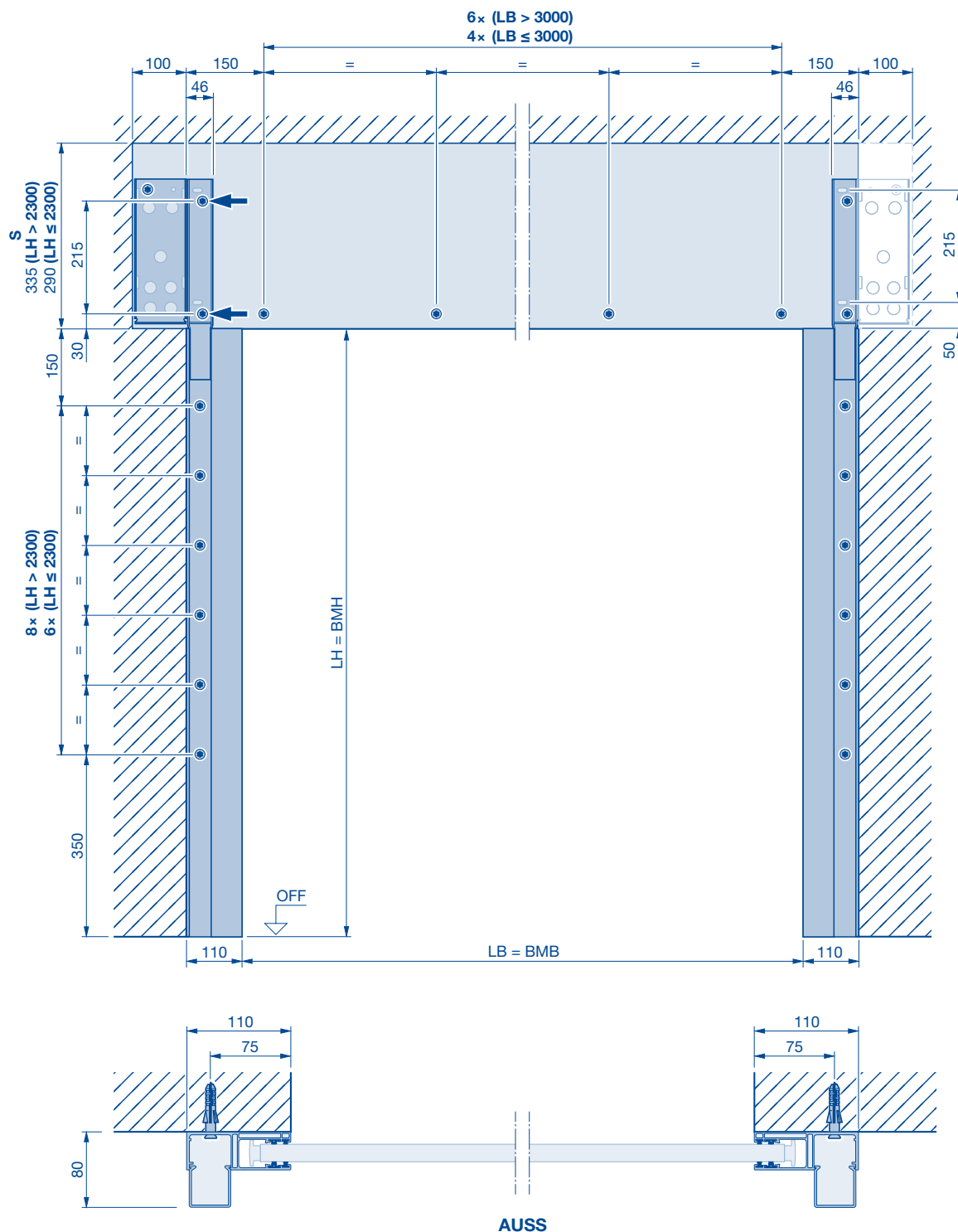

**AUSS** Exterior  
**BMB** Ordering size width  
**BMH** Ordering size height  
**LB** Clear width

**LH** Clear height  
**S** Required headroom  
**OFF** Finished floor level

# Connections for Control and Emergency Release

Roller garage door / rolling grille RollMatic

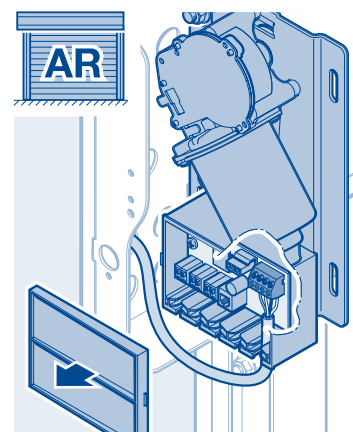
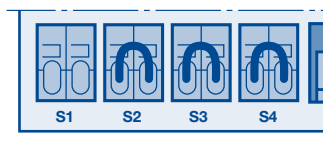
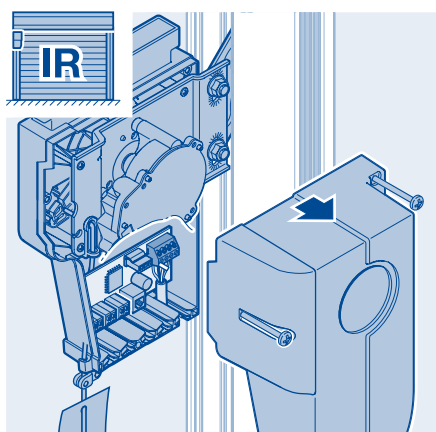
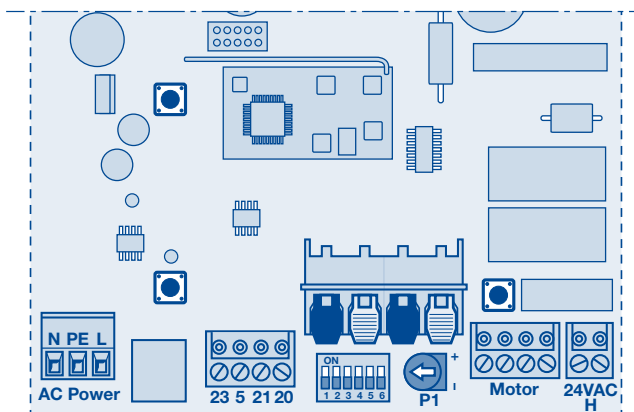
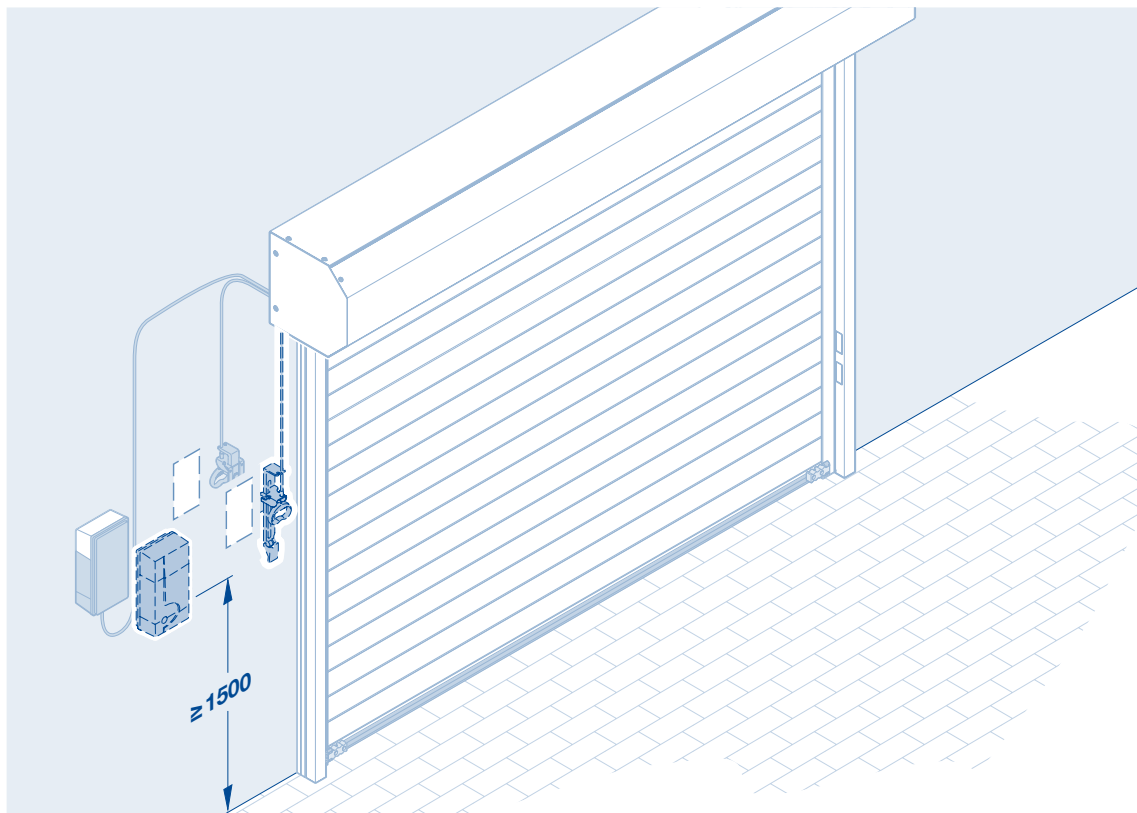

# Overhead garage door RollMatic OD

## Viewed from outside

### Door curtain

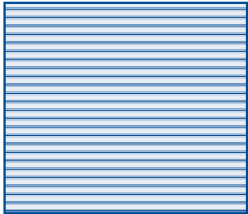

## Size range

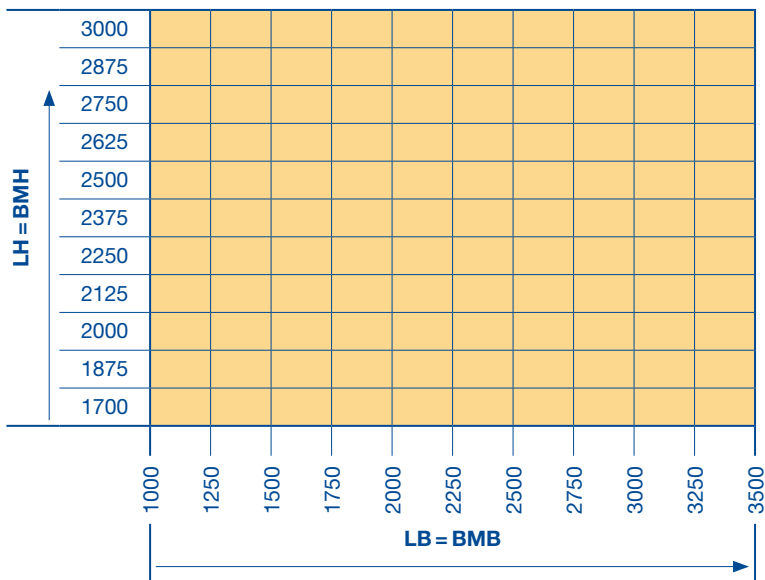

 RollMatic OD

**BMB** Ordering size width  
**BMH** Ordering size height  
**LB** Clear width  
**LH** Clear height

# Fitting Types

## Overhead garage door RollMatic OD

### Fitting behind the opening

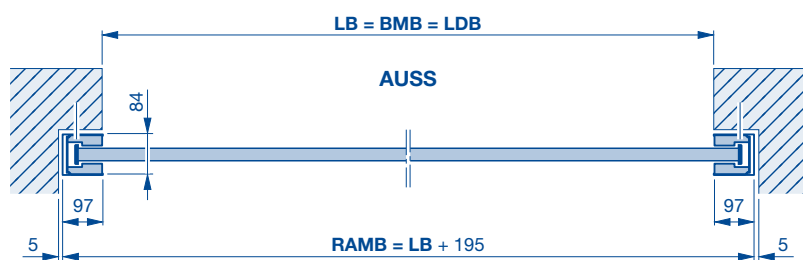
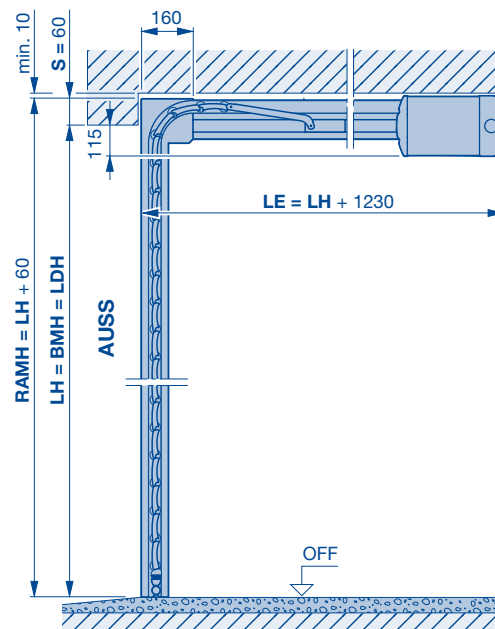
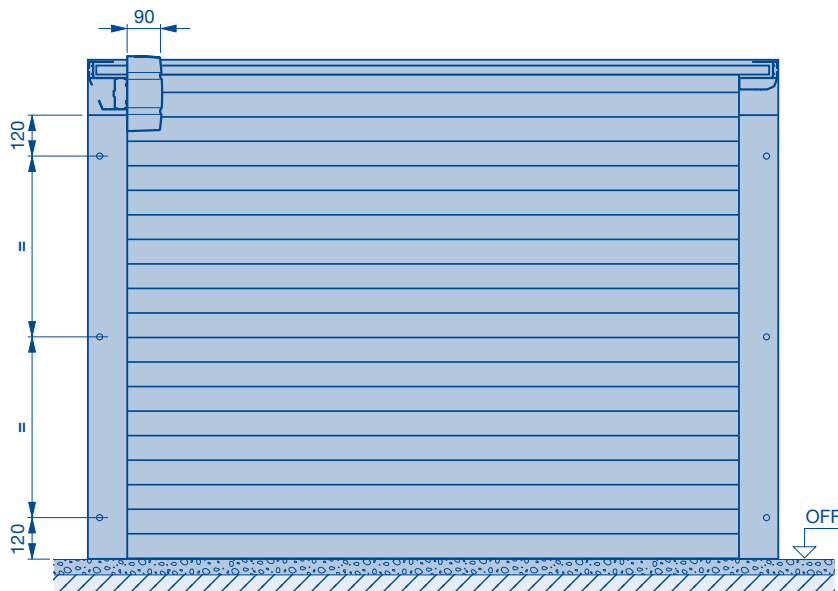

<b>AUSS</b>	Exterior
<b>BMB</b>	Ordering size width
<b>BMH</b>	Ordering size height
<b>LB</b>	Clear width

<b>LDB</b>	Clear passage width
<b>LE</b>	Fitting depth with operator
<b>LH</b>	Clear height
<b>LDH</b>	Clear passage height

<b>RAMB</b>	Overall frame dimension width
<b>RAMH</b>	Overall frame dimension height
<b>S</b>	Required headroom
<b>OFF</b>	Finished floor level

# Fitting Types

## Overhead garage door RollMatic OD

### Fitting in the opening

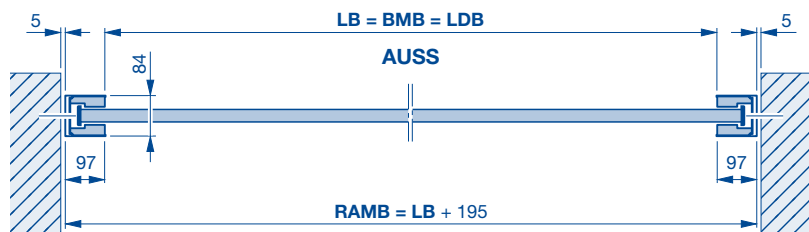
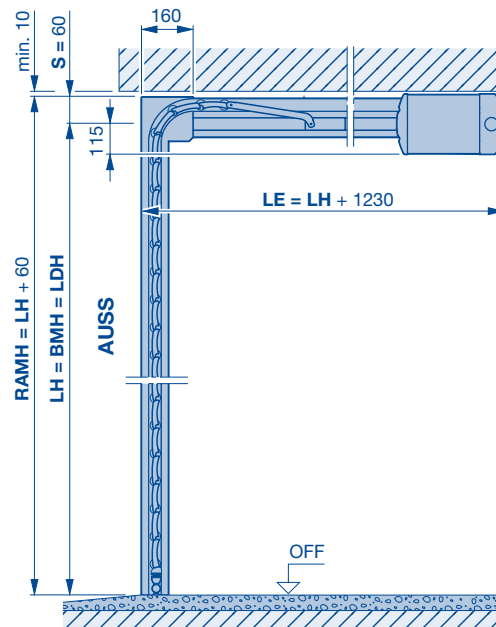
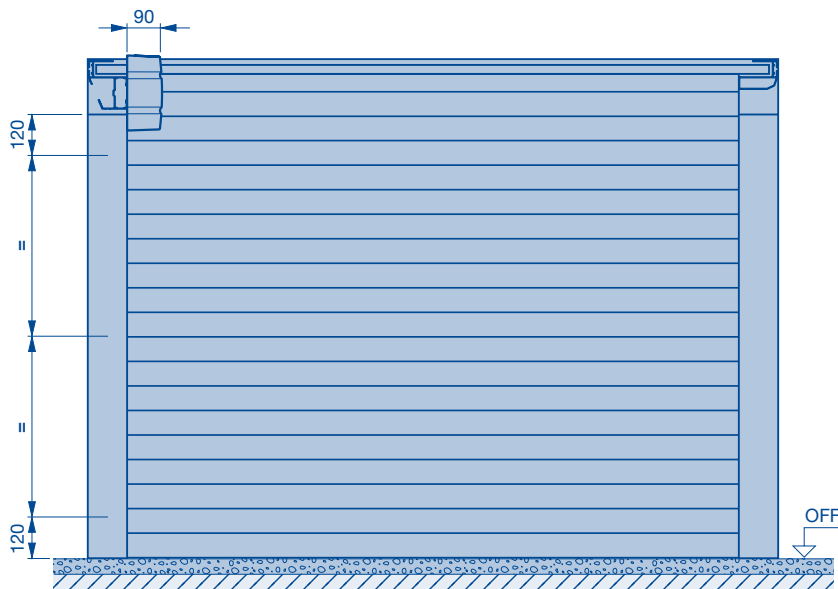

**AUSS** Exterior  
**BMB** Ordering size width  
**BMH** Ordering size height  
**LB** Clear width

**LDB** Clear passage width  
**LE** Fitting depth with operator  
**LH** Clear height  
**LDH** Clear passage height

**RAMB** Overall frame dimension width  
**RAMH** Overall frame dimension height  
**S** Required headroom  
**OFF** Finished floor level

# Fitting Types

## Overhead garage door RollMatic OD

### Fitting in the opening – flush-fitting with fascia frame 95

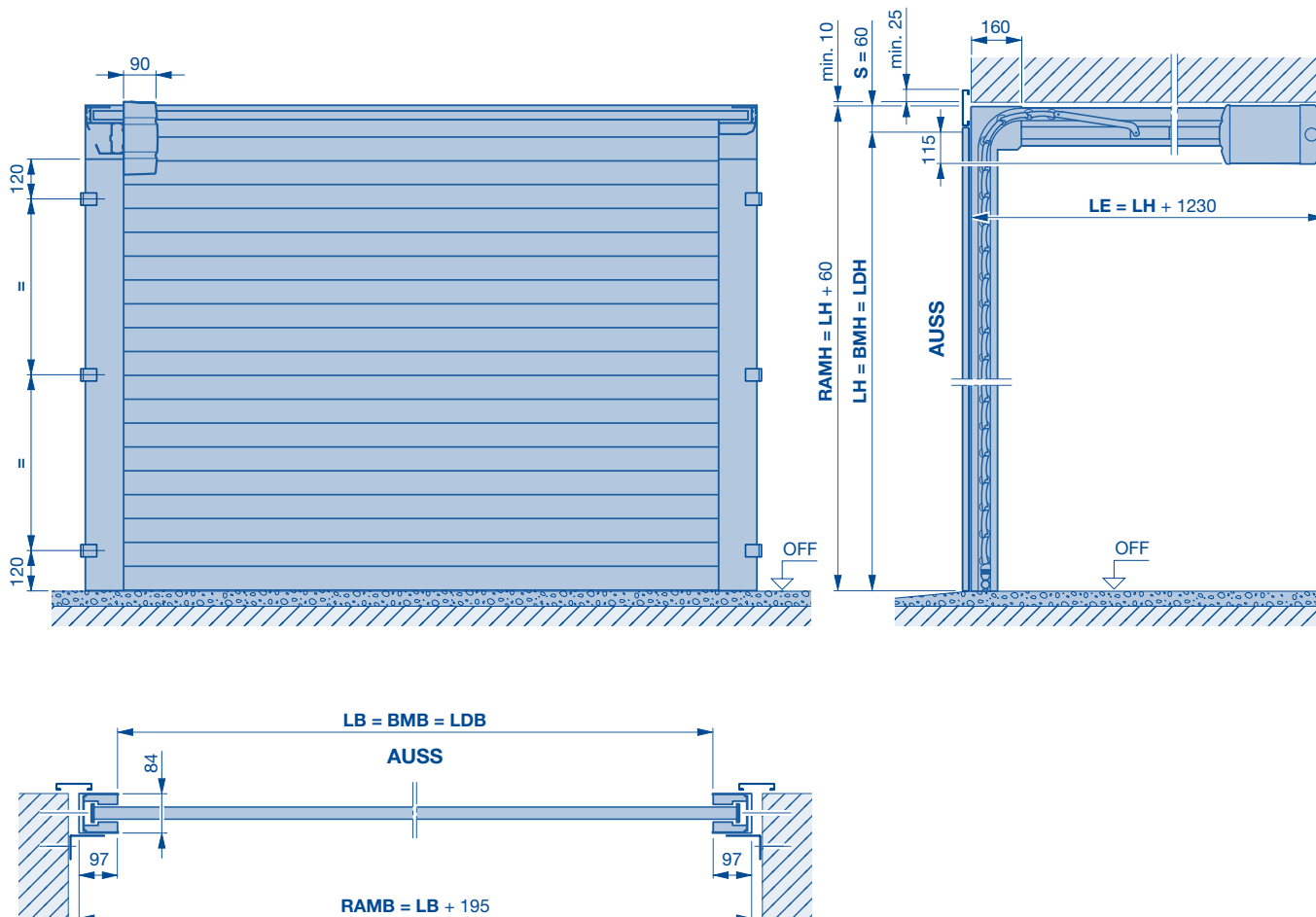

**Note:**

**LB** = max. 3150 mm

**LH** = max. 2700 mm

<b>AUSS</b>	Exterior
<b>BMB</b>	Ordering size width
<b>BMH</b>	Ordering size height
<b>LB</b>	Clear width

<b>LDB</b>	Clear passage width
<b>LE</b>	Fitting depth with operator
<b>LH</b>	Clear height
<b>LDH</b>	Clear passage height

<b>RAMB</b>	Overall frame dimension width
<b>RAMH</b>	Overall frame dimension height
<b>S</b>	Required headroom
<b>OFF</b>	Finished floor level



# Fixing Points

## Overhead garage door RollMatic OD

### Fitting behind the opening

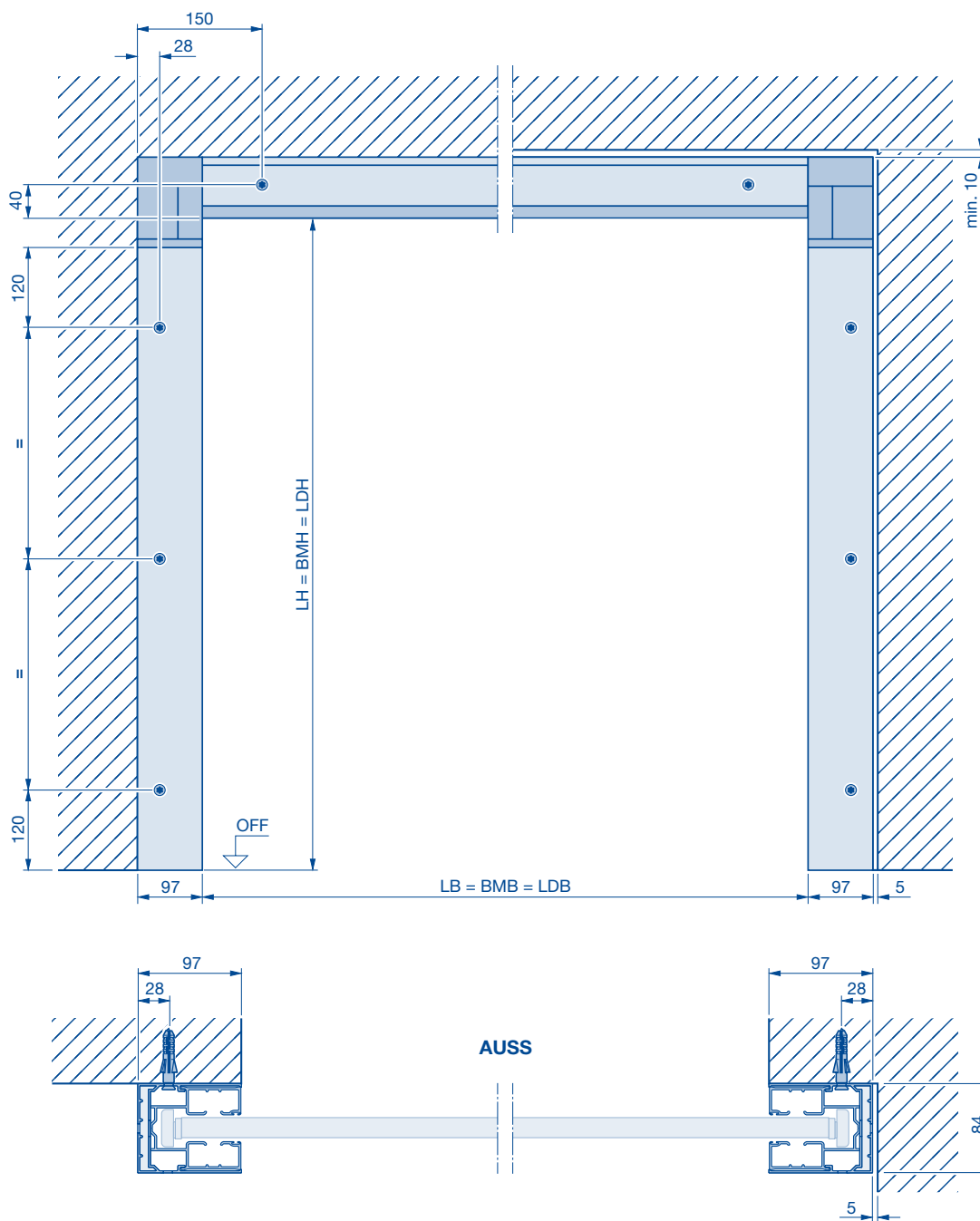

<b>AUSS</b>	Exterior
<b>BMB</b>	Ordering size width
<b>BMH</b>	Ordering size height
<b>LB</b>	Clear width

<b>LDB</b>	Clear passage width
<b>LH</b>	Clear height
<b>LDH</b>	Clear passage height
<b>S</b>	Required headroom

<b>OFF</b>	Finished floor level
------------	----------------------

# Fixing Points

## Overhead garage door RollMatic OD

### Fitting in the opening

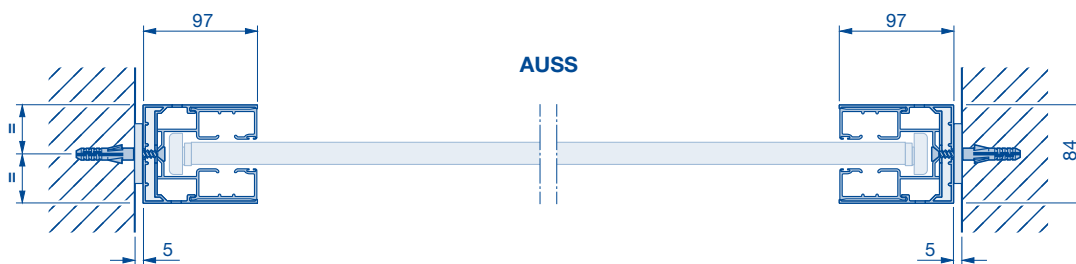
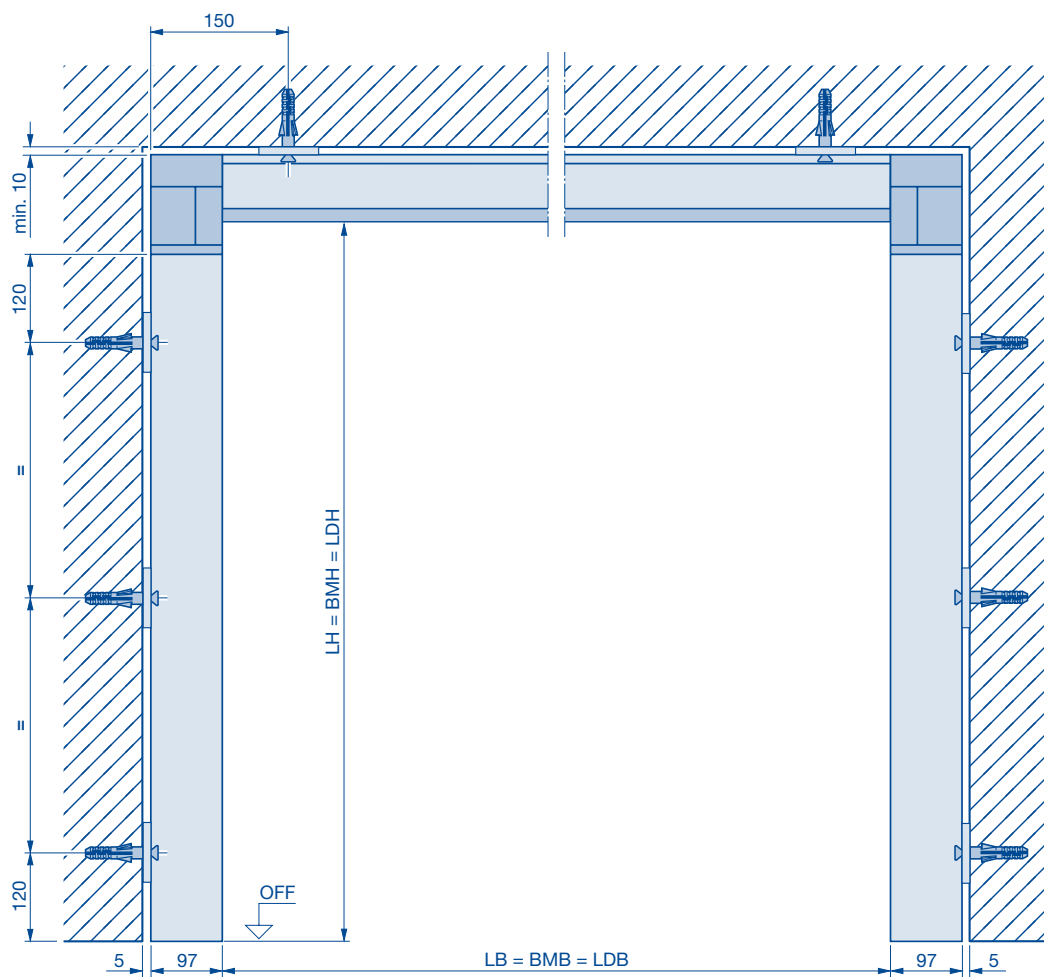

<b>AUSS</b>	Exterior
<b>BMB</b>	Ordering size width
<b>BMH</b>	Ordering size height
<b>LB</b>	Clear width

<b>LDB</b>	Clear passage width
<b>LH</b>	Clear height
<b>LDH</b>	Clear passage height
<b>SBH</b>	Additional fascia panel height

<b>OFF</b>	Finished floor level
------------	----------------------

# Fixing Points

## Overhead garage door RollMatic OD

Fitting in the opening – flush-fitting with fascia frame 95

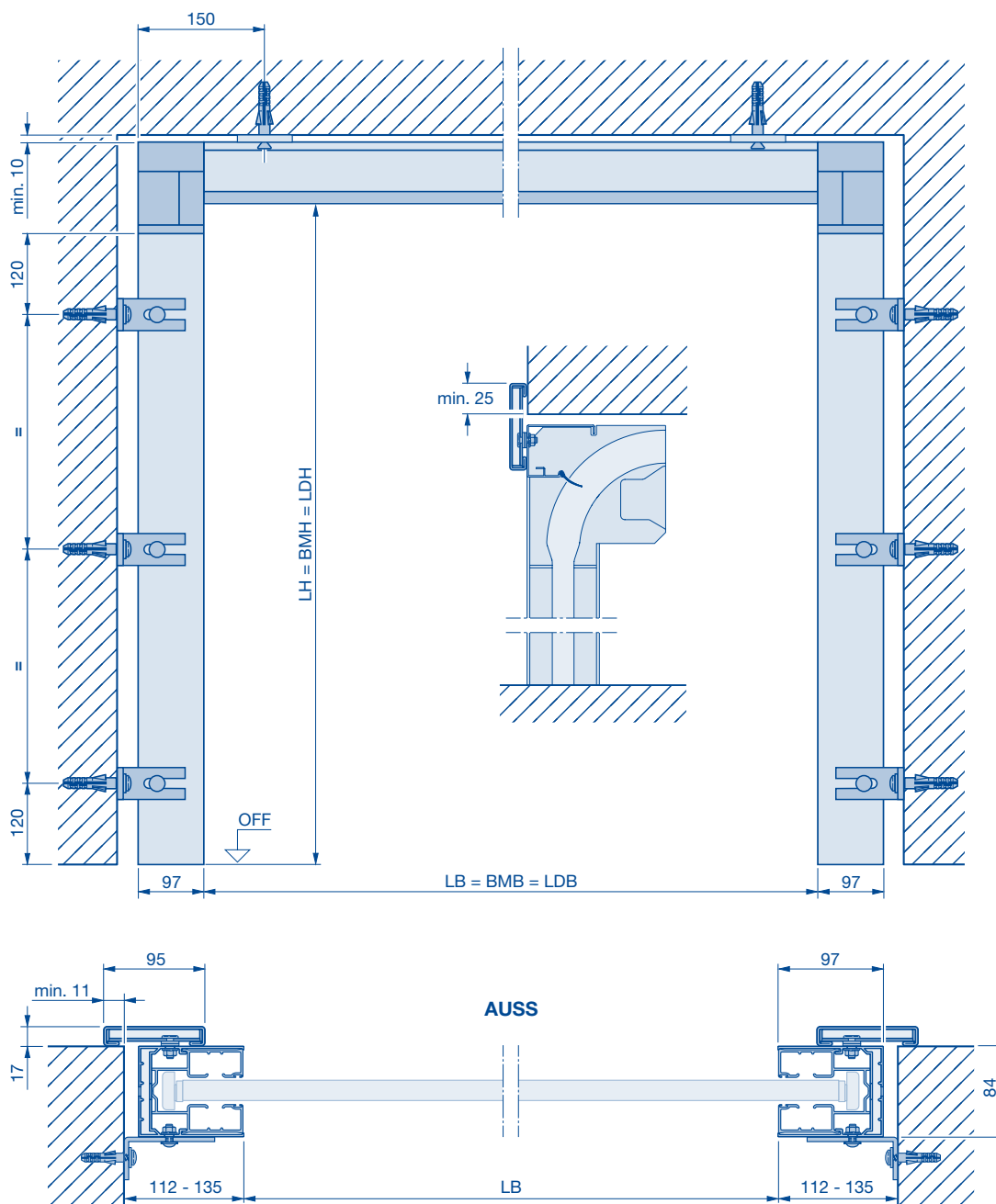

**AUSS** Exterior  
**BMB** Ordering size width  
**BMH** Ordering size height  
**LB** Clear width

**LDB** Clear passage width  
**LH** Clear height  
**LDH** Clear passage height  
**LMB** Structural opening width

**S** Required headroom  
**OFF** Finished floor level

# Vertical track fastening and distance back

Overhead garage door RollMatic OD

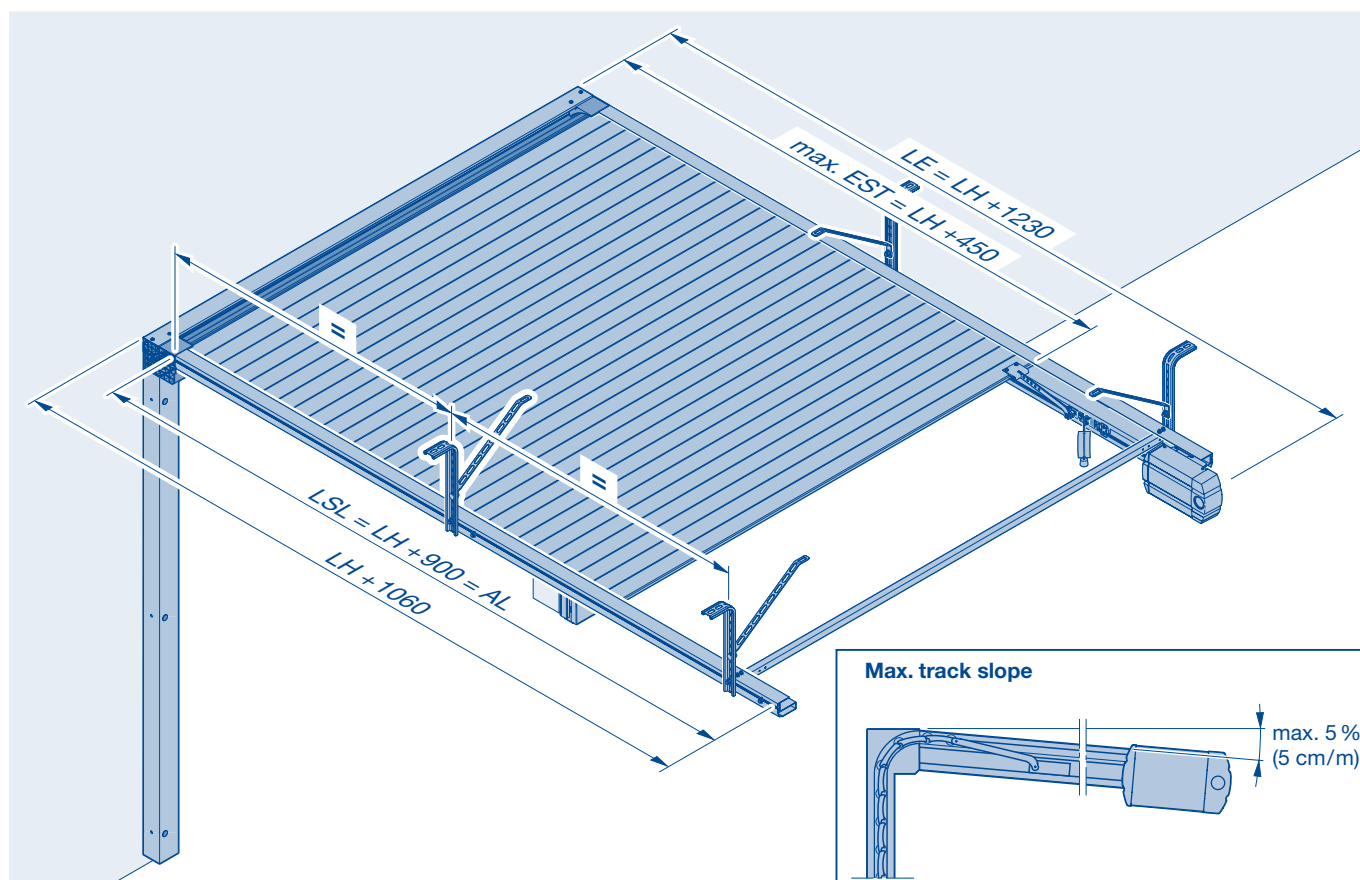

## Fixing variants

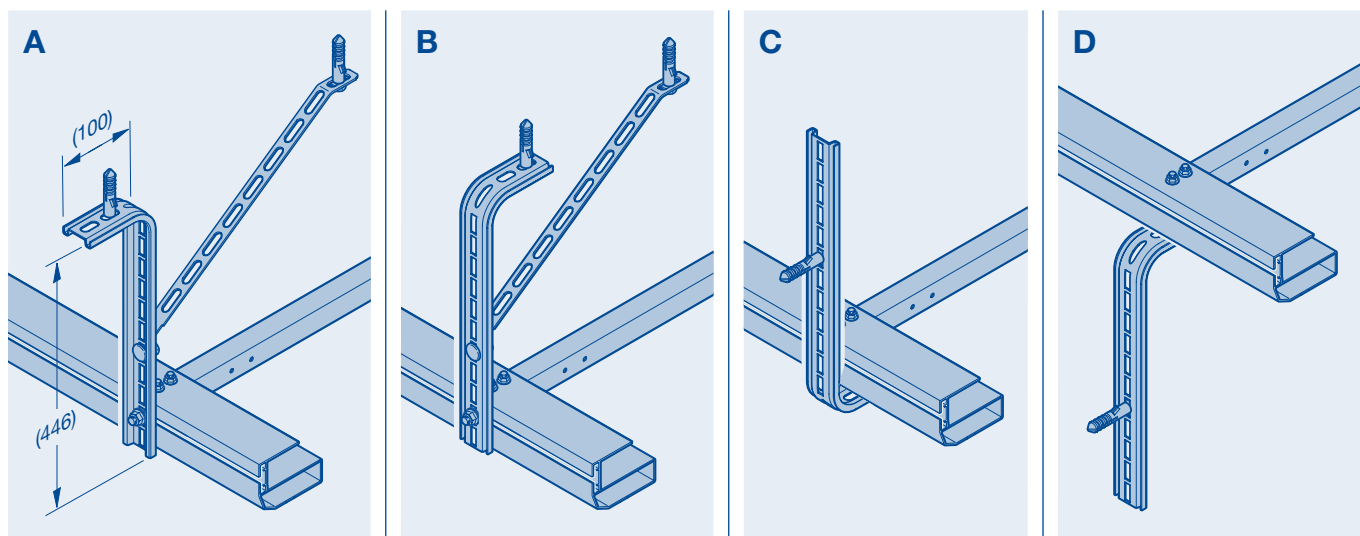

**AL** Operator boom length  
**EST** Door leaf distance back  
**LE** Distance back with operator  
**LH** Clear height

**LSL** Track length

# Rolling Grille RollMatic HG 75 TD

## Viewed from outside

Door curtain HG 75 TD, straight

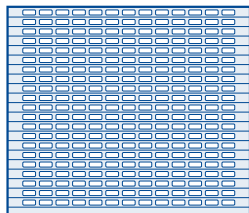

Door curtain HG 75 TD, offset

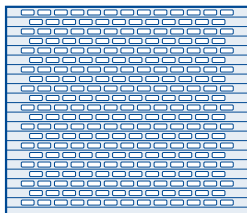

**Notes:**

For fitting in combination with the automatic sliding door AD 100-X, see technical manual HF 86889.

## Size range

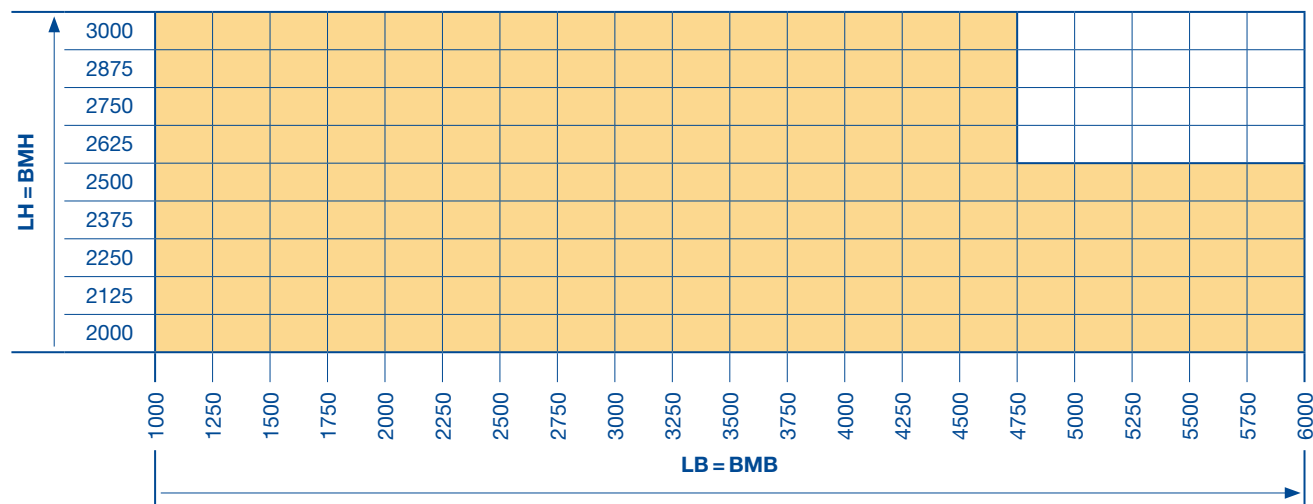

 RollMatic HG 75 TD

**BMB** Ordering size width  
**BMH** Ordering size height  
**LB** Clear width  
**LH** Clear height

# Fitting Types

## Rolling grille HG 75 TD

### Fitting in the opening behind the lintel - with / without thermal insulation

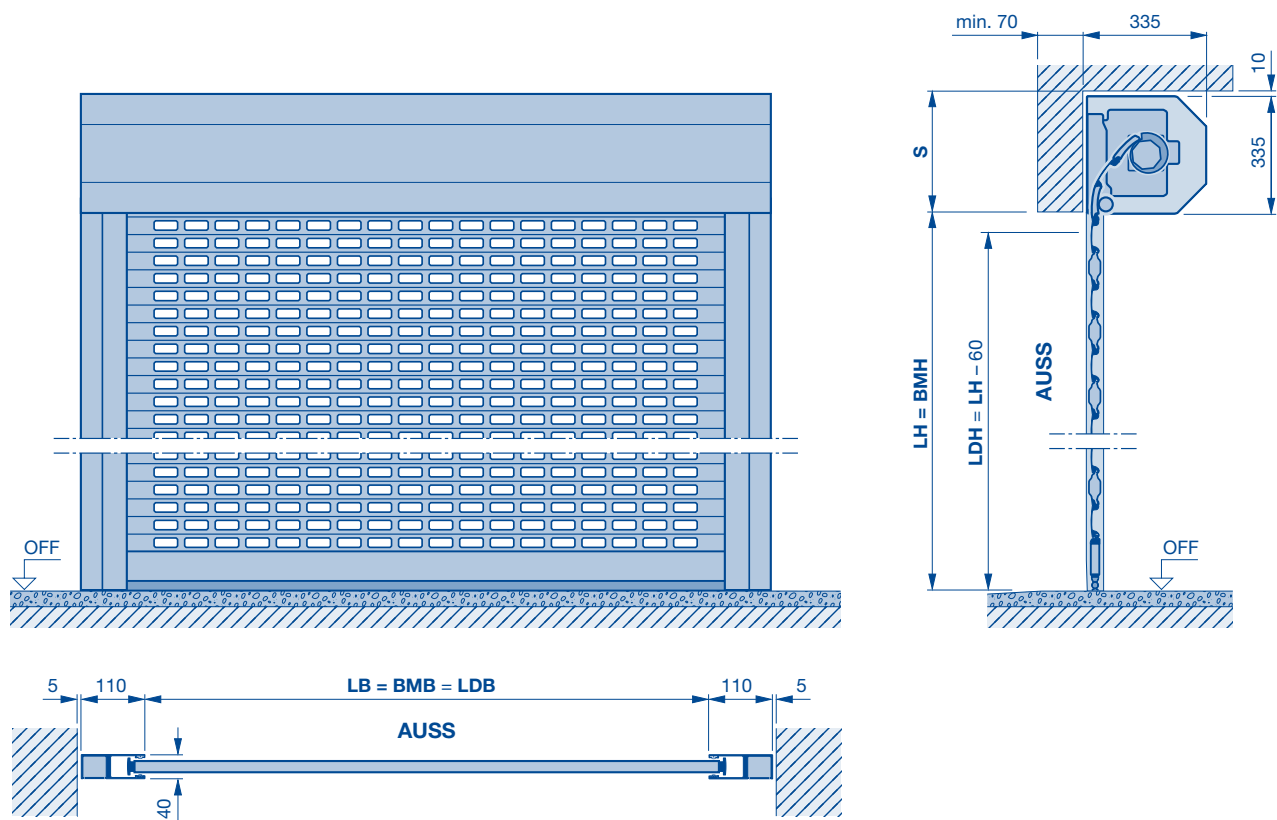

### With thermal insulation

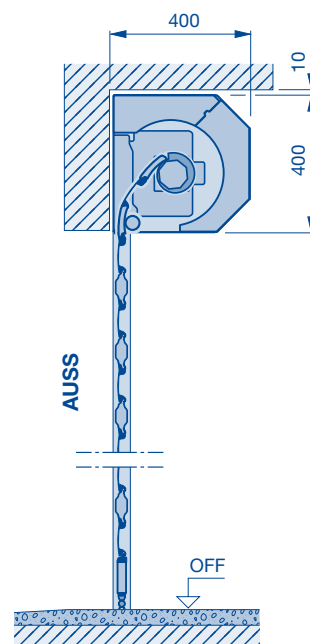

<b>AUSS</b>	Exterior
<b>BMB</b>	Ordering size width
<b>BMH</b>	Ordering size height
<b>LB</b>	Clear width

<b>LDB</b>	Clear passage width
<b>LH</b>	Clear height
<b>LDH</b>	Clear passage height
<b>S</b>	Required headroom

<b>OFF</b>	Finished floor level
------------	----------------------

# Fitting Types

## Rolling grille HG 75 TD

### Fitting in the opening with additional fascia panel - with / without thermal insulation

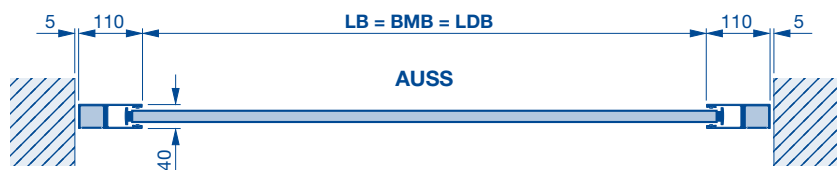
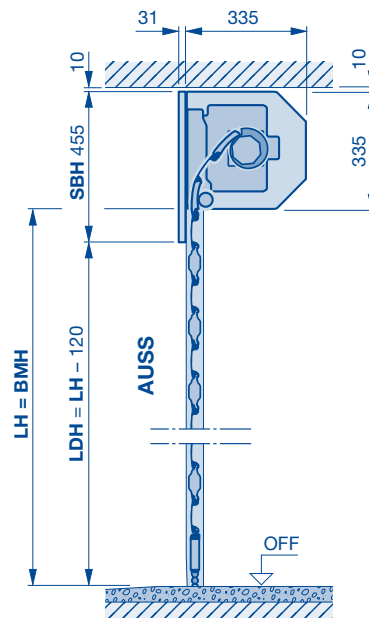
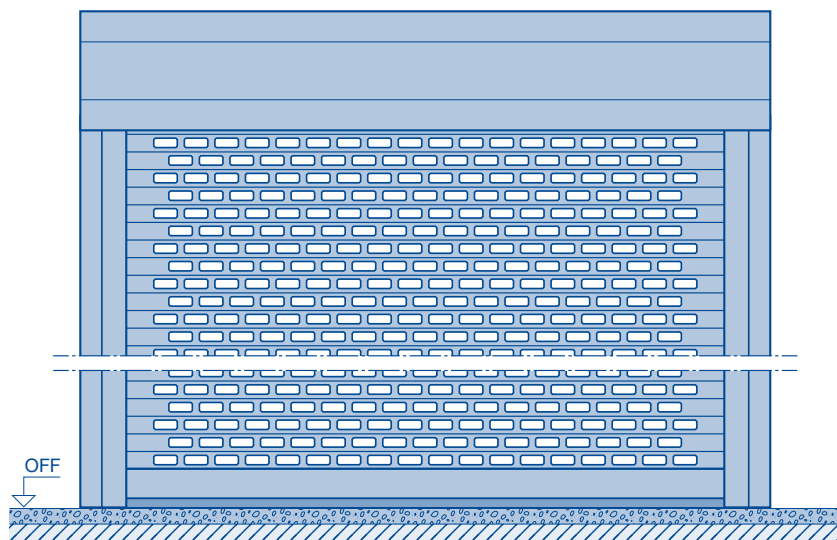

### With thermal insulation

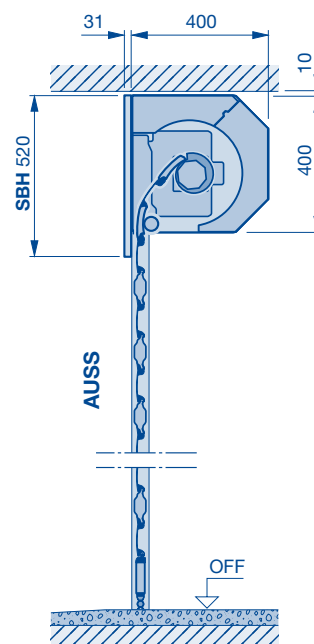

**Note:**

An additional fascia panel is required!

<b>AUSS</b>	Exterior
<b>BMB</b>	Ordering size width
<b>BMH</b>	Ordering size height
<b>LB</b>	Clear width

<b>LDB</b>	Clear passage width
<b>LH</b>	Clear height
<b>LDH</b>	Clear passage height
<b>SBH</b>	Additional fascia panel height

<b>OFF</b>	Finished floor level
------------	----------------------

# Fitting Types

## Rolling grille HG 75 TD

### Fitting from inside behind the opening – with / without thermal insulation

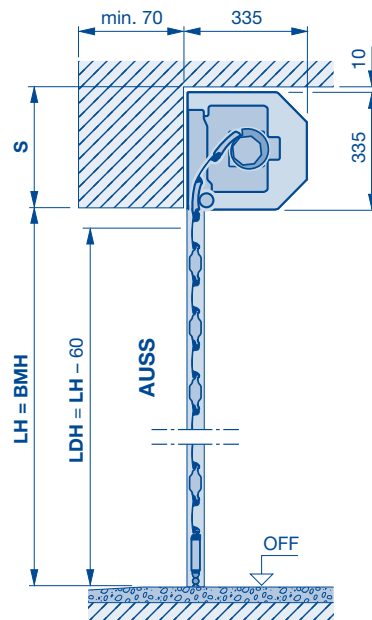
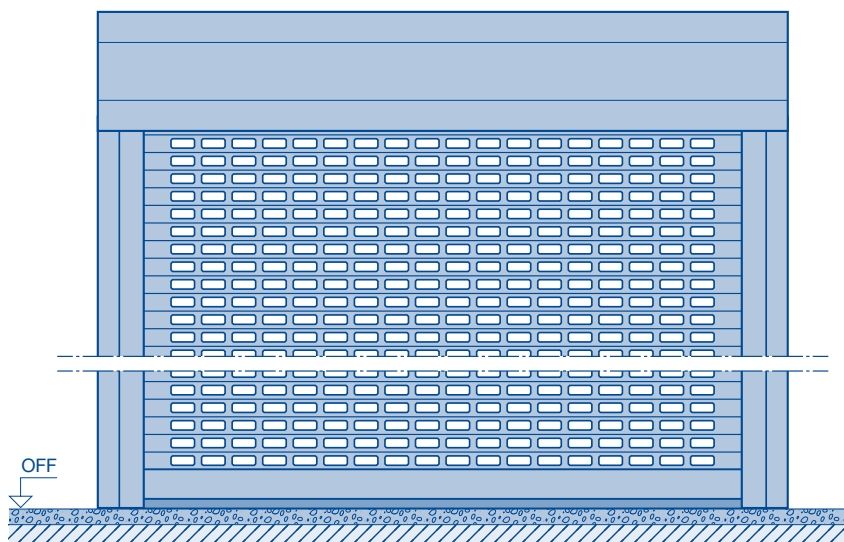

### With thermal insulation

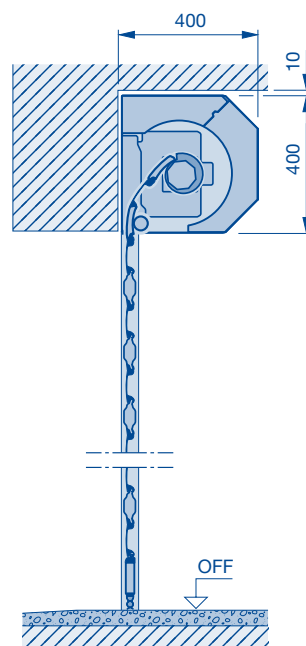

<b>AUSS</b>	Exterior
<b>BMB</b>	Ordering size width
<b>BMH</b>	Ordering size height
<b>LB</b>	Clear width

<b>LDB</b>	Clear passage width
<b>LH</b>	Clear height
<b>LDH</b>	Clear passage height
<b>S</b>	Required headroom

<b>OFF</b>	Finished floor level
------------	----------------------



# Fixing Points

## Rolling grille HG 75 TD

### Fitting in the opening behind the lintel

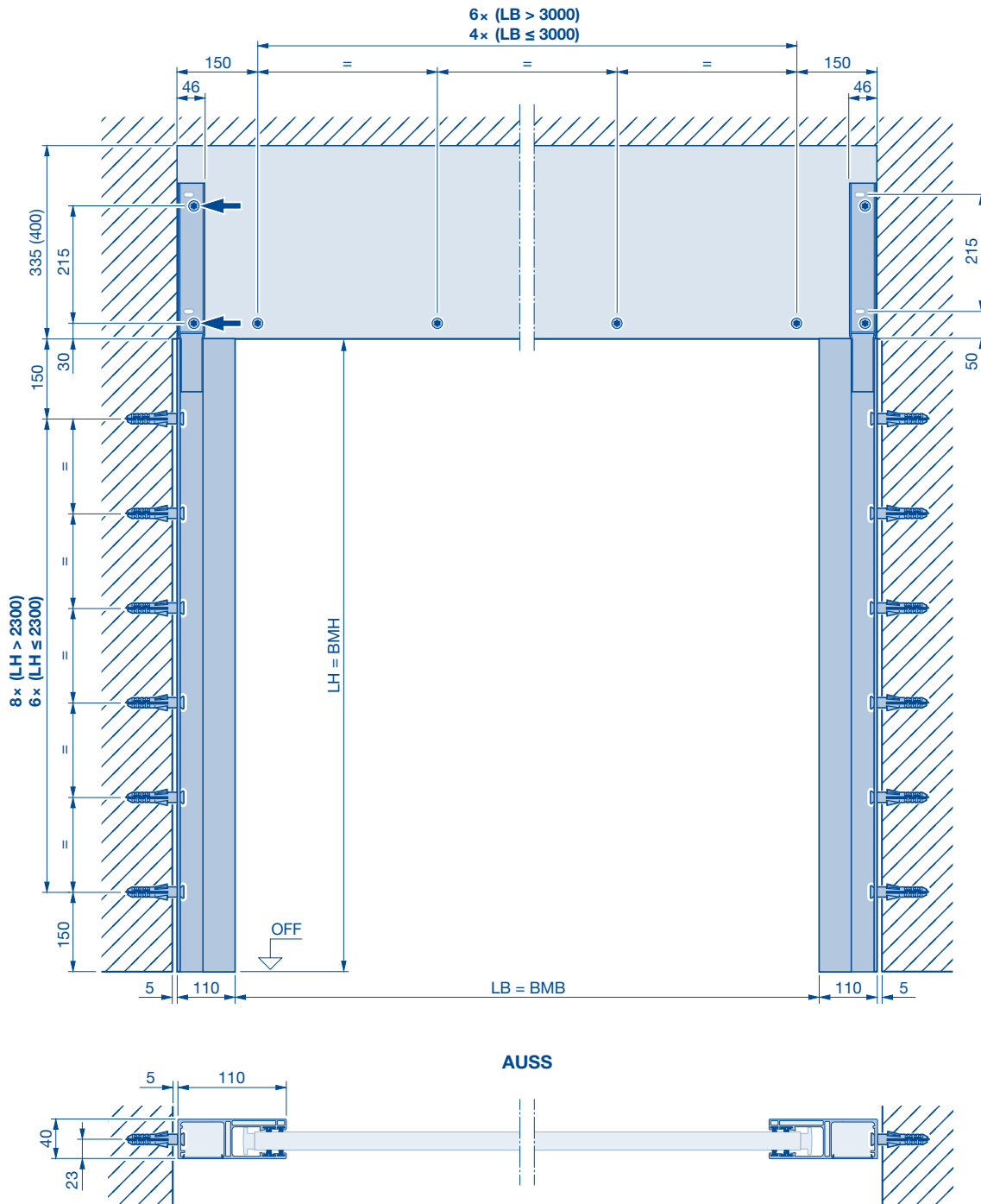

**AUSS** Exterior  
**BMB** Ordering size width  
**BMH** Ordering size height  
**LB** Clear width

**LH** Clear height  
**OFF** Finished floor level

# Fixing Points

## Rolling grille HG 75 TD

Fitting in the opening with an additional fascia panel

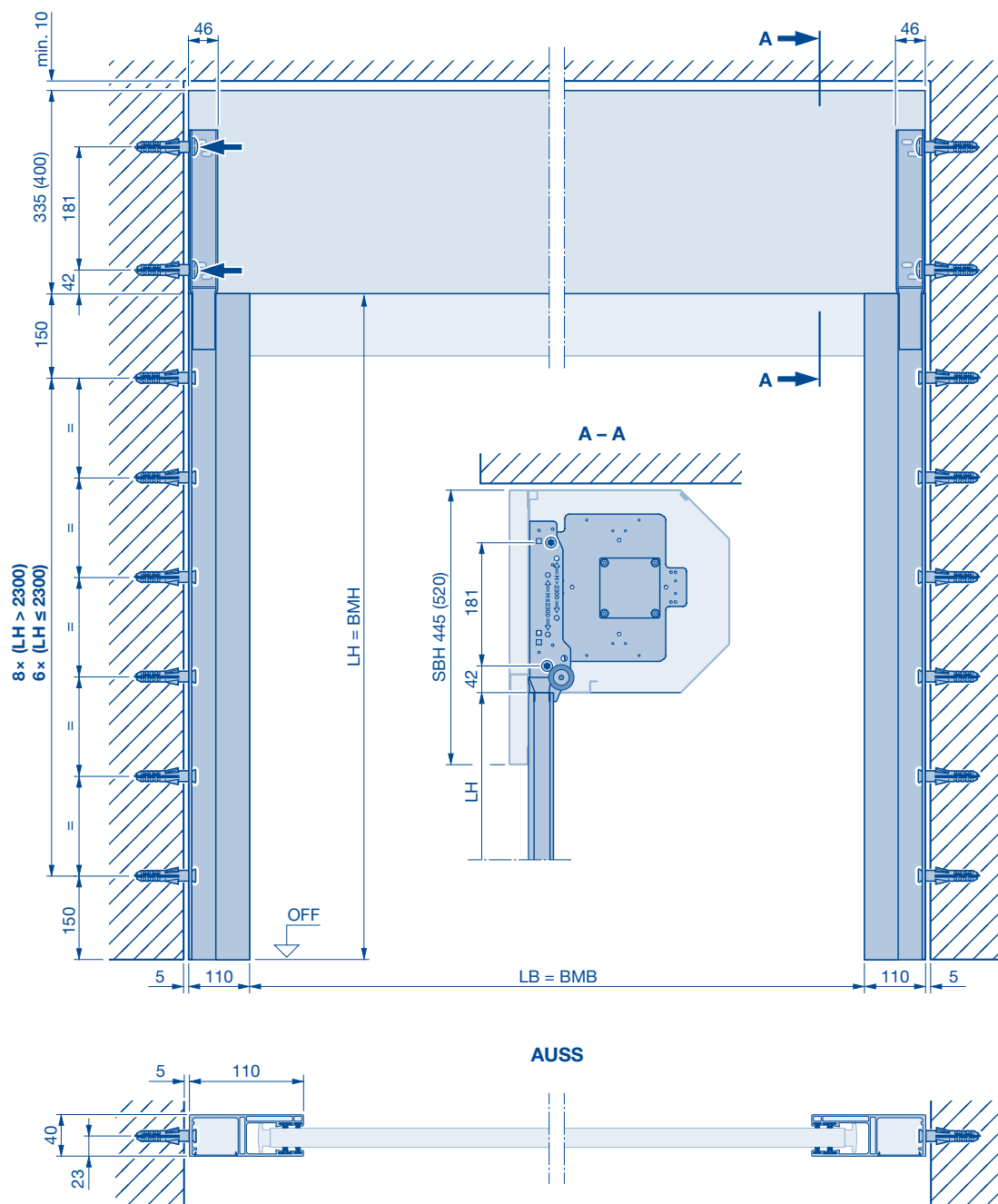

**AUSS** Exterior  
**BMB** Ordering size width  
**BMH** Ordering size height  
**LB** Clear width

**LH** Clear height  
**SBH** Additional fascia panel height  
**OFF** Finished floor level

# Fixing Points

## Rolling grille HG 75 TD

### Fitting from inside behind the opening

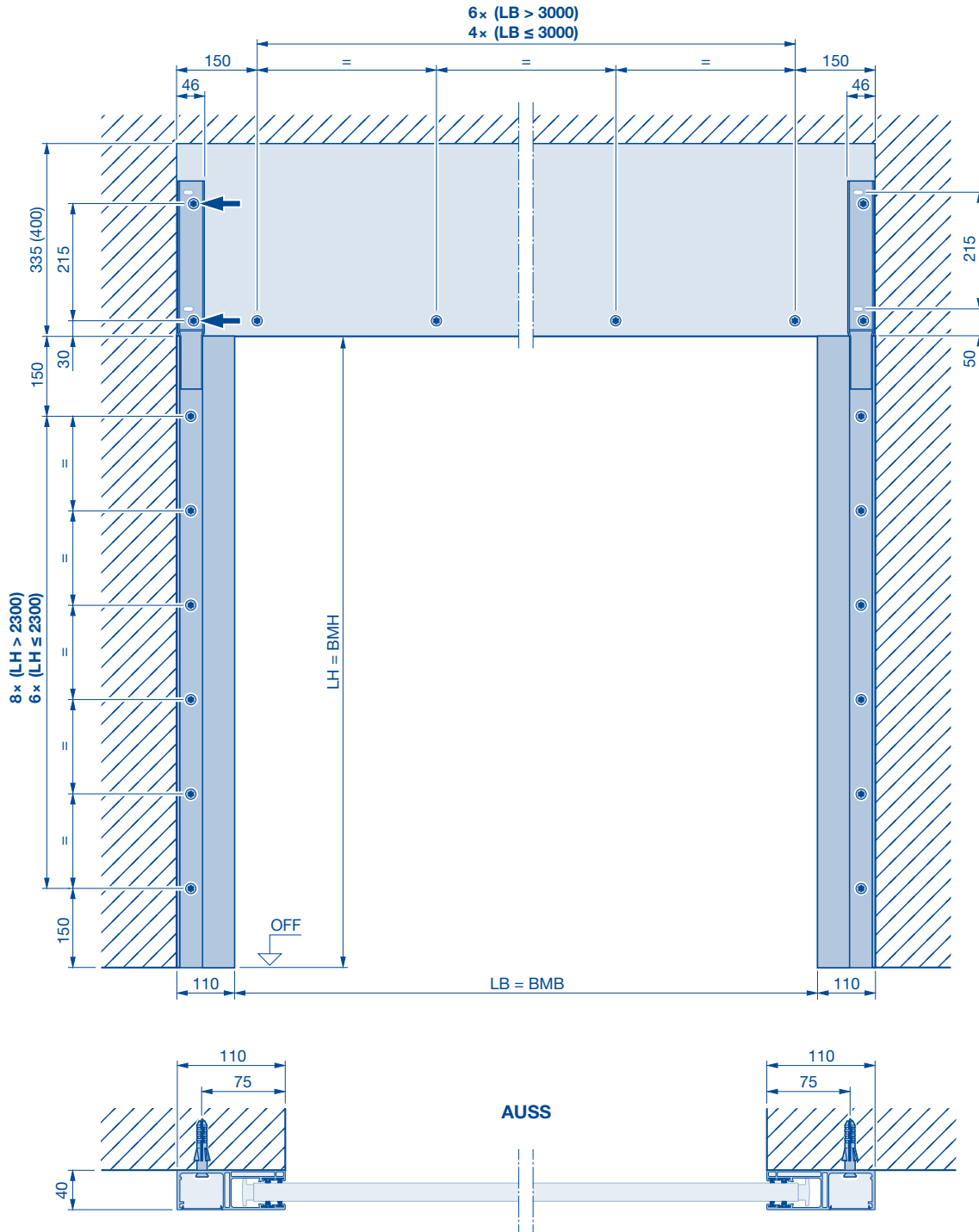

**AUSS** Exterior  
**BMB** Ordering size width  
**BMH** Ordering size height  
**LB** Clear width

**LH** Clear height  
**OFF** Finished floor level

# Electrical Connections

## Rolling grille HG 75 TD

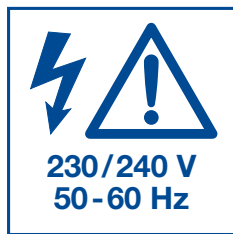
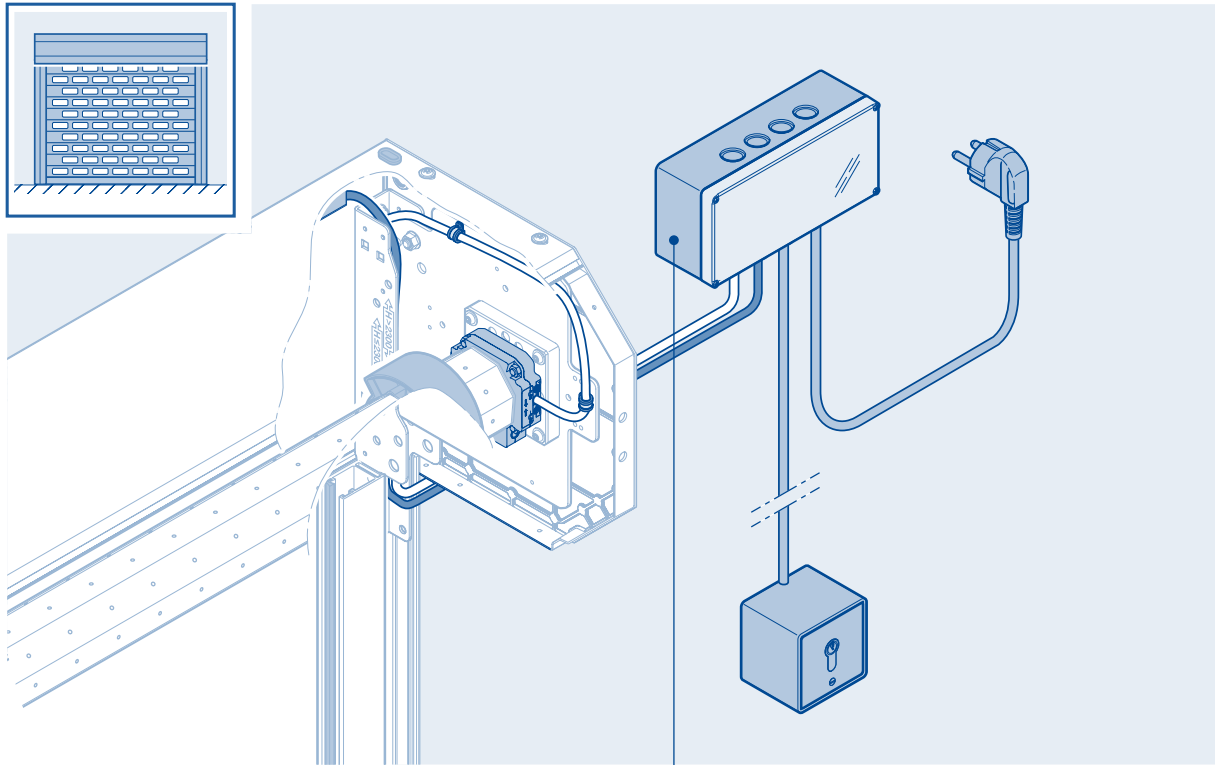

145×65×45 mm

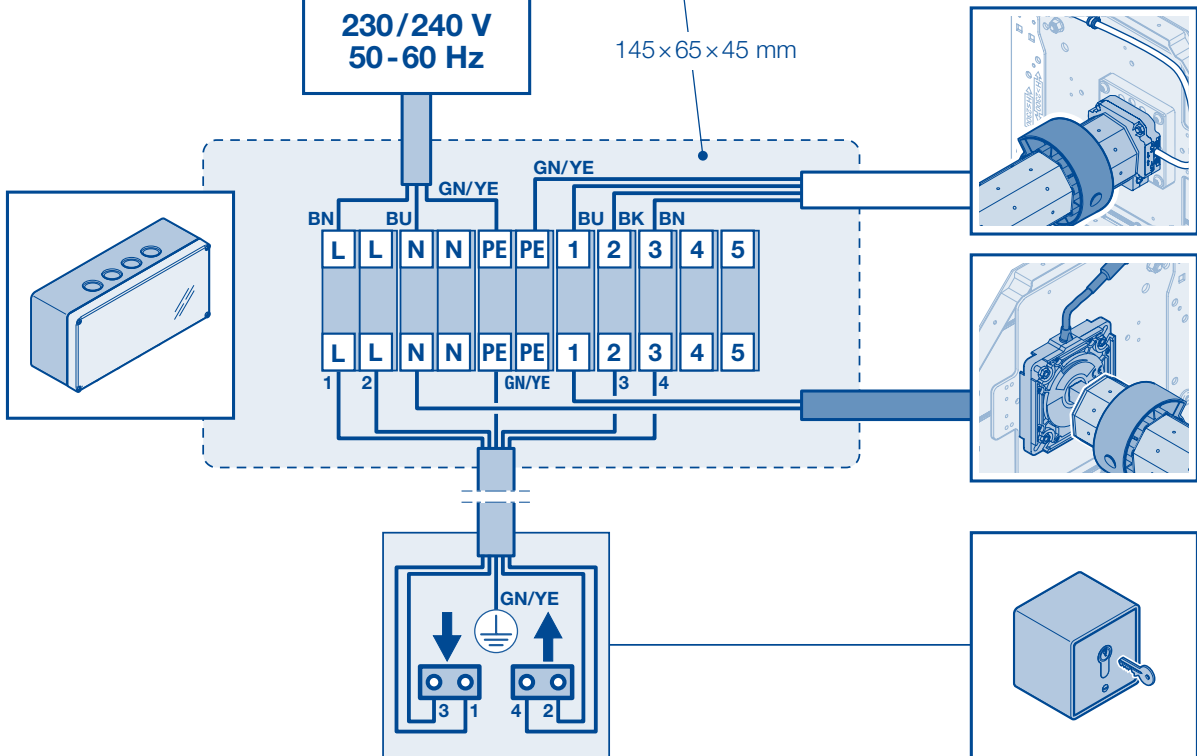

# Side Door NT 60

With corner frame made of aluminium profiles

Profile type 4

## Viewed from outside

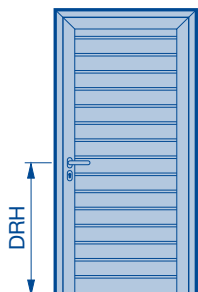

## Size range

Ordering size = BRB × BRH		
Width × height		DRH from OFF
<b>From</b>	<b>875 × 1800</b>	1050
<b>up to</b>	<b>1284 × 2500</b>	

**BRB** Nominal size width  
**BRH** Nominal size height  
**DRH** Lever height  
**OFF** Finished floor level

# Side Door NT 60

With corner frame made of aluminium profiles

Profile type 4

## Opening inwards

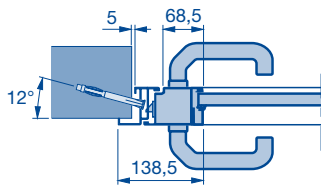

## Opening outwards

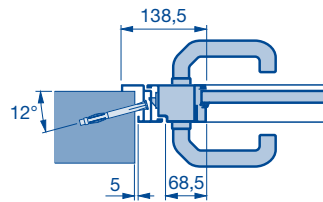

### Internal fitting opening inwards

Matching internal roller garage doors

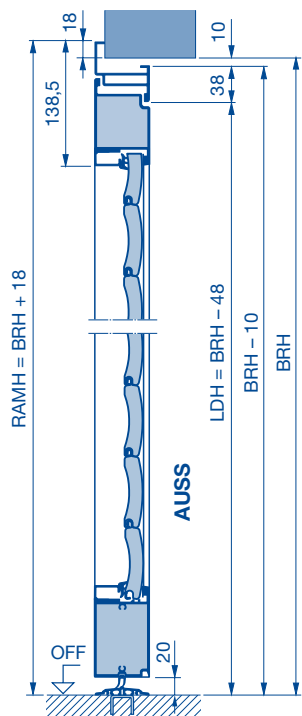

Matching external roller garage doors

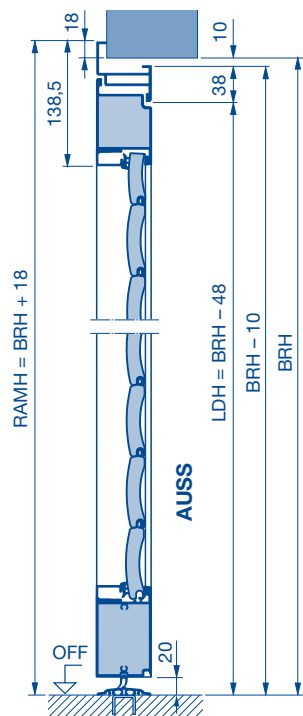

### External fitting opening outwards

Matching internal roller garage doors

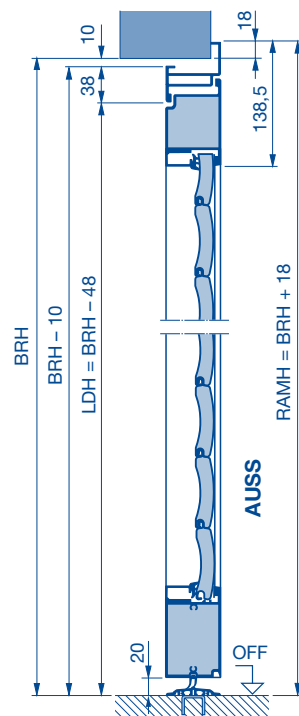

Matching external roller garage doors

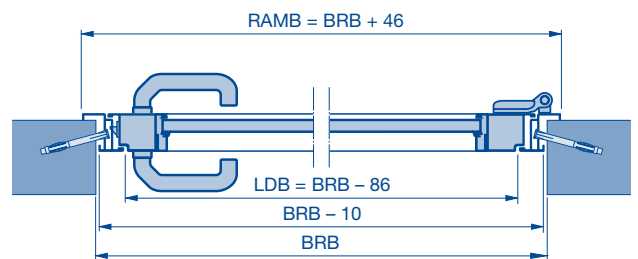
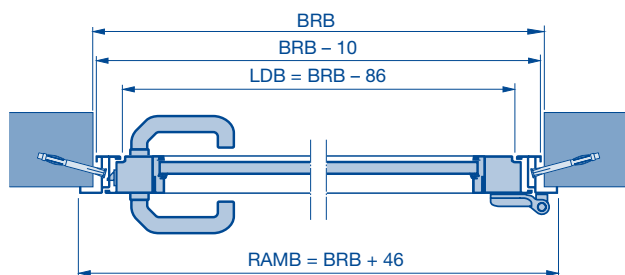
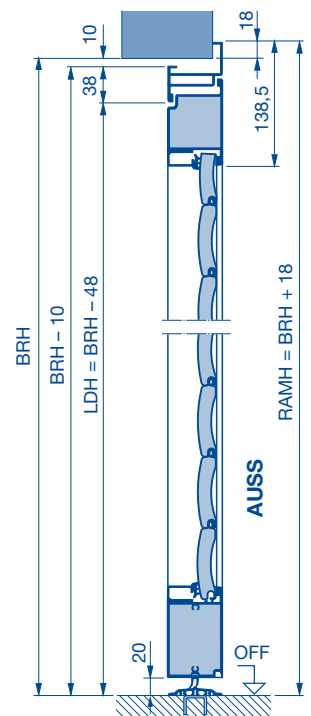

**AUSS** Exterior  
**BRB** Nominal size width  
**BRH** Nominal size height  
**LDB** Clear passage width

**LDH** Clear passage height  
**RAMB** Overall frame dimension width  
**RAMH** Overall frame dimension height  
**OFF** Finished floor level

# Side Door NT 60

With corner frame made of aluminium profiles

Optimal position of anchors

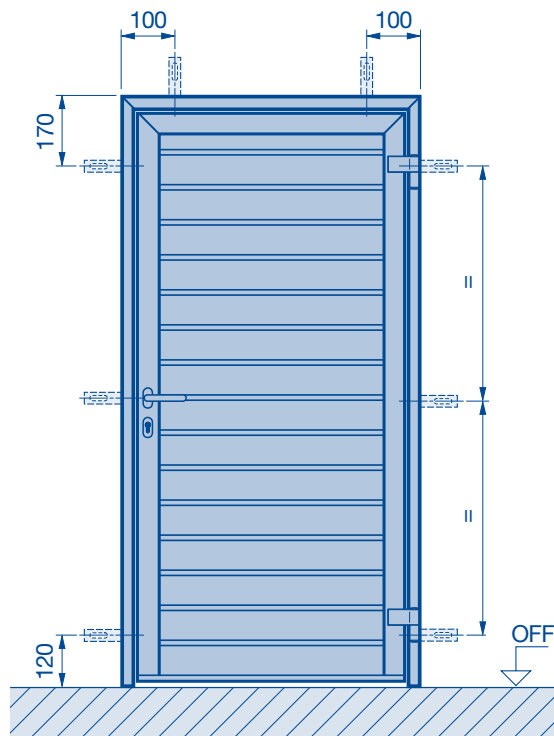

OFF Finished floor level

# Side Door NT 60

With block frame made of aluminium profiles

Profile type 4

## Viewed from outside

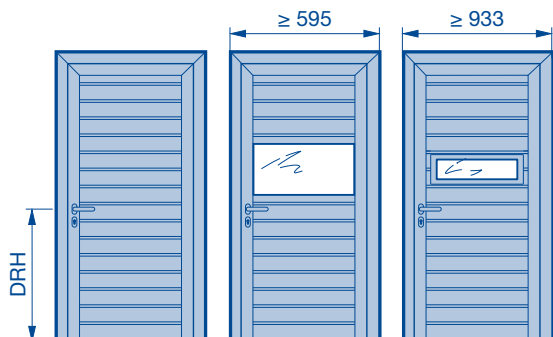

## Size range

Ordering sizes = RAM		DRH from OFF
Width x height		
From	875 x 1800	1050
up to	1284 x 2500	

**DRH** Lever height  
**RAM** Overall frame dimensions  
**OFF** Finished floor level



# Side Door NT 60

With block frame made of aluminium profiles

Profile type 4

Opening inwards

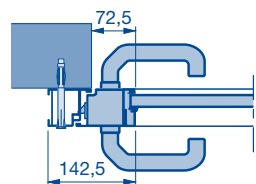

Opening inwards or outwards

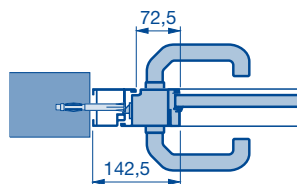

## Fitting behind the opening/opening inwards

Matching internal roller garage doors

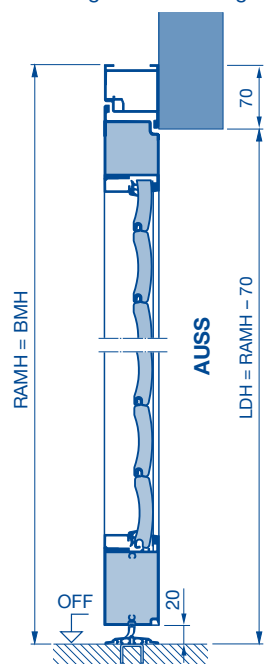

Matching external roller garage doors

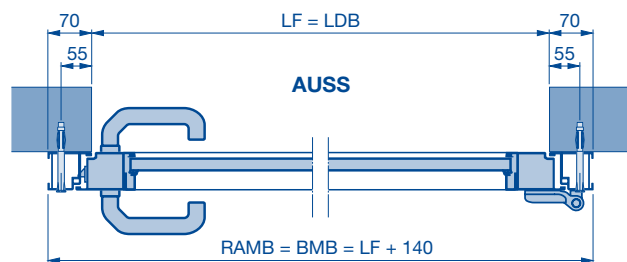
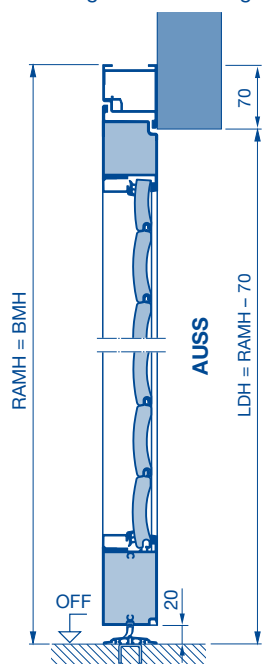

**AUSS** Exterior  
**BRB** Nominal size width  
**BRH** Nominal size height  
**LDB** Clear passage width

**LDH** Clear passage height  
**LF** Structural opening  
**RAMB** Overall frame dimension width  
**RAMH** Overall frame dimension height

**OFF** Finished floor level

# Side Door NT 60

With block frame made of aluminium profiles

Profile type 4

## Fitting in the opening, opening inwards

Matching internal roller garage doors

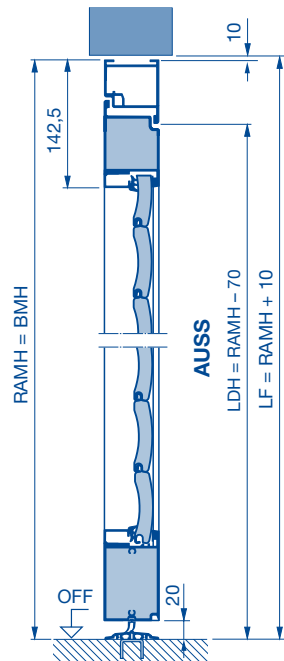

Matching external roller garage doors

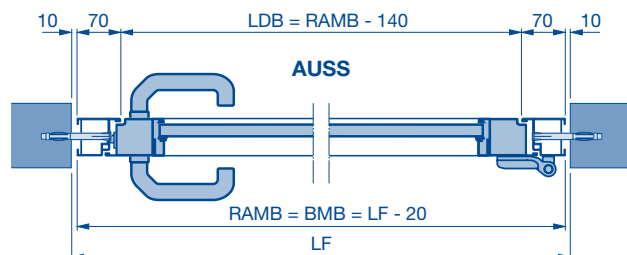
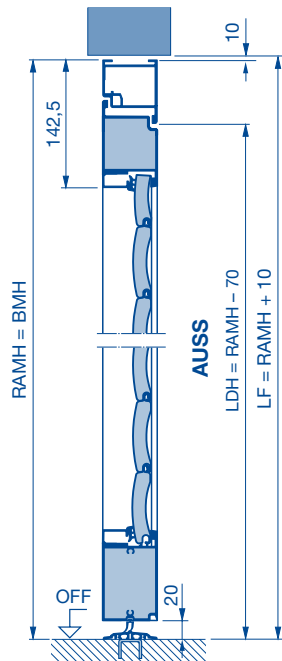

<b>AUSS</b>	Exterior
<b>BRB</b>	Nominal size width
<b>BRH</b>	Nominal size height
<b>LDB</b>	Clear passage width

<b>LDH</b>	Clear passage height
<b>LF</b>	Structural opening
<b>RAMB</b>	Overall frame dimension width
<b>RAMH</b>	Overall frame dimension height

<b>OFF</b>	Finished floor level
------------	----------------------

# Side Door NT 60

With block frame made of aluminium profiles

Profile type 4

## Fitting in the opening, opening outwards

Matching internal roller garage doors

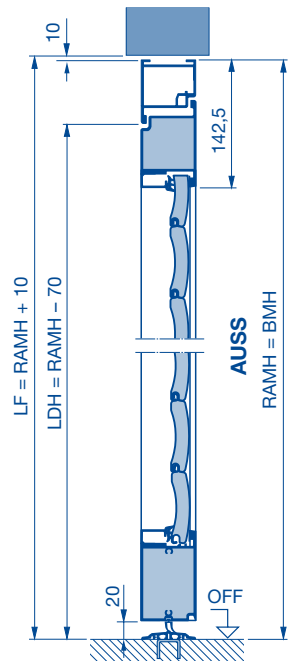

Matching external roller garage doors

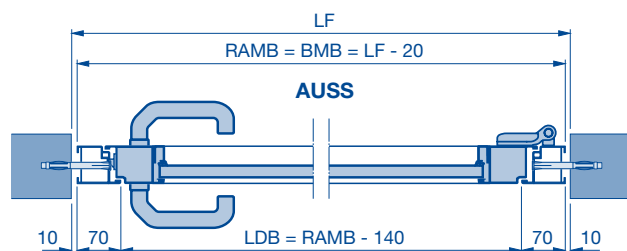
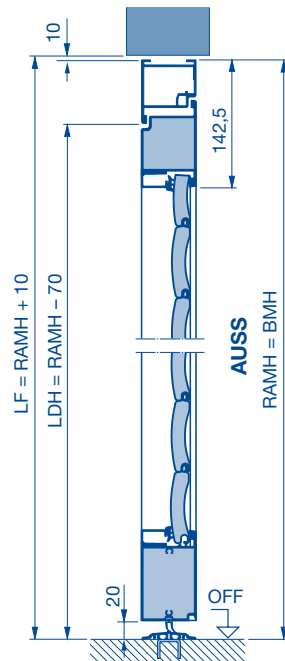

<b>AUSS</b>	Exterior
<b>BRB</b>	Nominal size width
<b>BRH</b>	Nominal size height
<b>LDB</b>	Clear passage width

<b>LDH</b>	Clear passage height
<b>LF</b>	Structural opening
<b>RAMB</b>	Overall frame dimension width
<b>RAMH</b>	Overall frame dimension height

<b>OFF</b>	Finished floor level
------------	----------------------

# Side Door NT 60

With block frame made of aluminium profiles

Optimal position of anchors

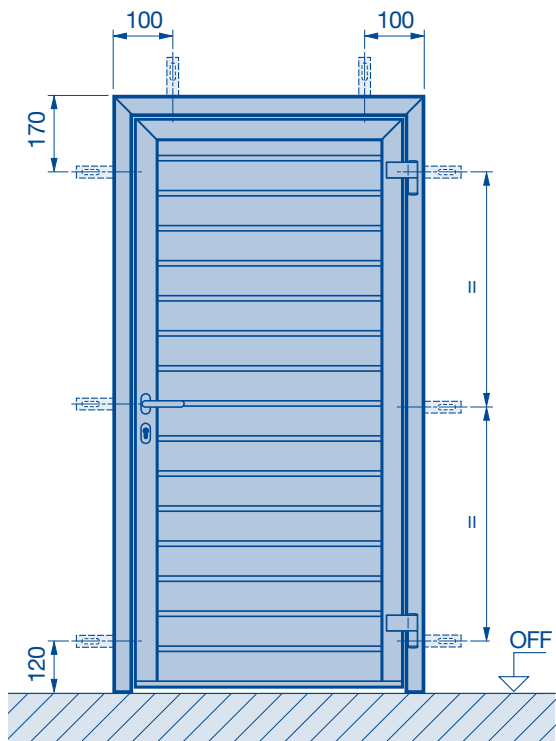

Screw fixing through the frame

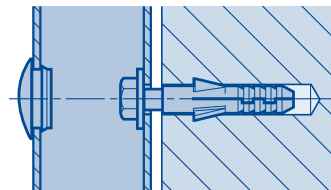

OFF Finished floor level