

# FITTING INSTRUCTIONS

GDO Side Hinged Garage Doors

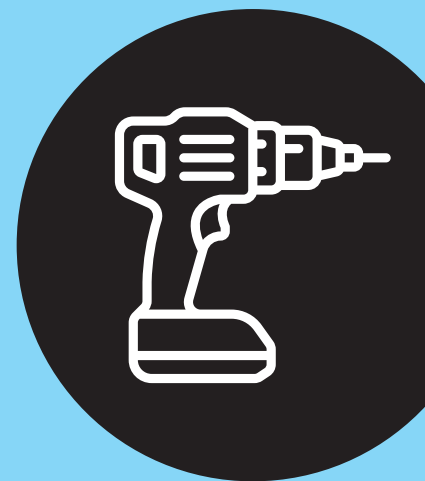

OCT 2022



## DOUBLE LEAF DOORS...

These instructions are suitable for double leaf doors.



## BEFORE YOU START...



**PLEASE READ THE INSTRUCTIONS THROUGH THOROUGHLY BEFORE INSTALLING. FAILURE TO FOLLOW THE INSTRUCTION WILL VOID THE PRODUCT GUARANTEES AND MAY RESULT IN PERSONAL INJURY.**

- This garage door is intended for domestic use only.
- Installation is a 2-person job.
- Wear suitable PPE! Safety shoes, eyes protection for drilling, etc. Garage doors are heavy and require appropriate handling. Always wear gloves to protect hands from any sharp edges.
- Do not attempt to install the door if you are unsure of any part of the instructions in this booklet.
- For advice call on: **01926 463888**



## FIXINGS...

The fixing pack supplied contains:

- 6no. 8x60 screws and plugs
- 6no. 8/92 expansion fixings
- 6no. fixing straps (Used when through the frame fixings cannot be made)
- Fixing hole cover grommets

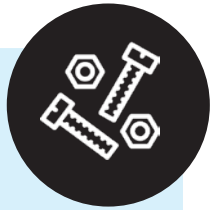

## TOOLS YOU WILL NEED...

- Spirit or laser levels - **IMPORTANT: laser levels are the recommended device as they are a precision instrument, effective when used in site conditions typical to a garage door opening aperture.**
- Drill & bits for fixing holes and shoot bolt keeps
- Pozidrive screw driver
- Allen key set including 3, 4 & 6mm for hinge adjustment and frame lug setting
- Spacers/wedges for frame setting if the wind-out lugs cannot set the frame as required
- Cleaning materials - car shampoo or similar (do not use turpentine or solvent)



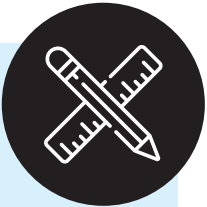

## THE OPENING...

**Before unpacking the door, check the opening!** Does the door size ordered fit?

Check the delivery notification to confirm sizes are as expected.

The opening in which the door is to be fitted should be in a suitable condition. For stability and long service life, adequate site work is essential.

The opening must be formed from materials of adequate strength and all brick or concrete. Block work should ideally be a minimum of 15N/mm<sup>2</sup>.

Aerated concrete is not recommended and hollow bricks/blocks should be suitably back-filled during opening construction to provide strength for the frame fixing bolts.

Where doors are to be installed into low density block work (7N/mm<sup>2</sup>) additional fixings may be required to ensure stability.

Openings must be plumb and square and the floor area within the arc swept by the door leaf must be level or fall away from the opening.

**The threshold must be flat/level and sound across the full width of the opening. A level or sloping threshold will be susceptible to water pooling that will run into the garage. You should consider a floor rebate and drainage channel in front of the door.**

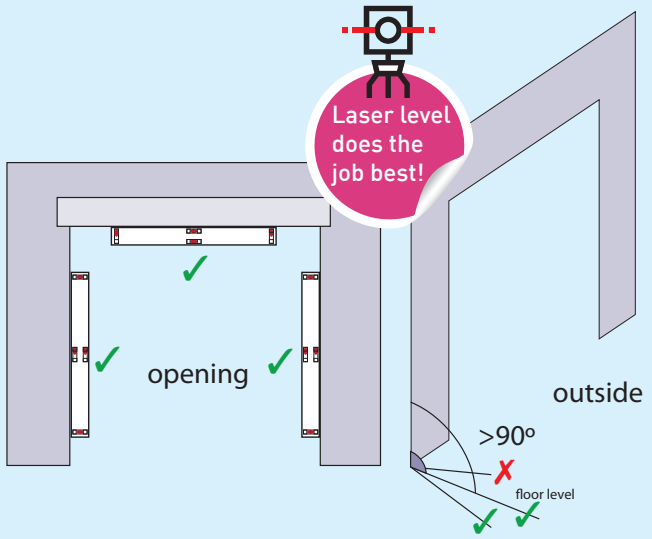

## DOOR PACKING...

**Check the packaging for signs of damage.** Doors are supplied fully assembled. Double leaf doors stays are fixed to the door leaves but will require fixing to the frame head.

Doors with the standard 3-part aluminium threshold do not have a transit strip. Doors ordered with the optional aluminium strip threshold have a transit strip between the frame legs that should be removed prior to installation.



## YOU'RE READY TO BEGIN INSTALLING...



1.

Lay the complete door and frame flat with the outer face uppermost (the hinged face) and the frame head towards the door opening.

**!** Ensure the frame is protected from abrasion by contact with the timbers surface.

Carefully unpack the door. **!** Do not use a blade or sharp edge!

Remove the transit strip.

2.

## FIT THE DOOR HANDLE



Lift and support the door.

Use the tumb turn to unlock and release the latch to open the door.

Insert the spindle and locate and secure the handle roses with the screws provided, ensuring the two holes without nutserts have the female receivers fitted on the external face of the door to prevent unauthorised removal of the handle. Fit the rose covers.

Slide on the handles, ensuring the logo on each handle is facing up (failure to orientate the handles correctly will prevent the handles correctly operating the latch).

Secure by tightening the grub screw and check both handles operates the latch.

3.

## SETTING THE DOOR AND FRAME IN THE OPENING



Carefully lift and position the complete door in the opening.

Position the frame to the front edge of the opening rebate. The frame can be positioned as required on the rebate, however care must be taken on deep rebates to protect the door leaf from striking the rebate if the door is allowed to open beyond 90°.

Open the door leaves and support and protect the bottom edge of the leaves.

Use the wind-out lugs as shown on the facing page to position and hold the door securely in the opening. Do not fix at this stage!

**!** Ensure the frame legs are plumb and the header is level. If you need to raise one of the frame legs (A) to level the header, this is because your threshold is not level. If packers or the wind-out lugs are used to raise a frame leg, **the threshold must be supported across its full length.**

**The aluminium strip threshold will require fixings, but do not fix until the door is correctly hung. Ensure fixings do not distort the threshold as this will compromise the closure of the door and the engagement of the seals.**

Shown without door leaves for clarity

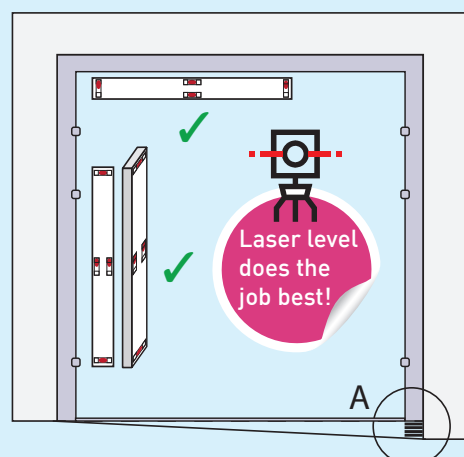



2 lugs at each of the four fixing points per side.



Lugs are accessed through the frame fixing hole.

Wind out all lugs. Failure to do this will result in frame twist and distortion when fixings are tightened.

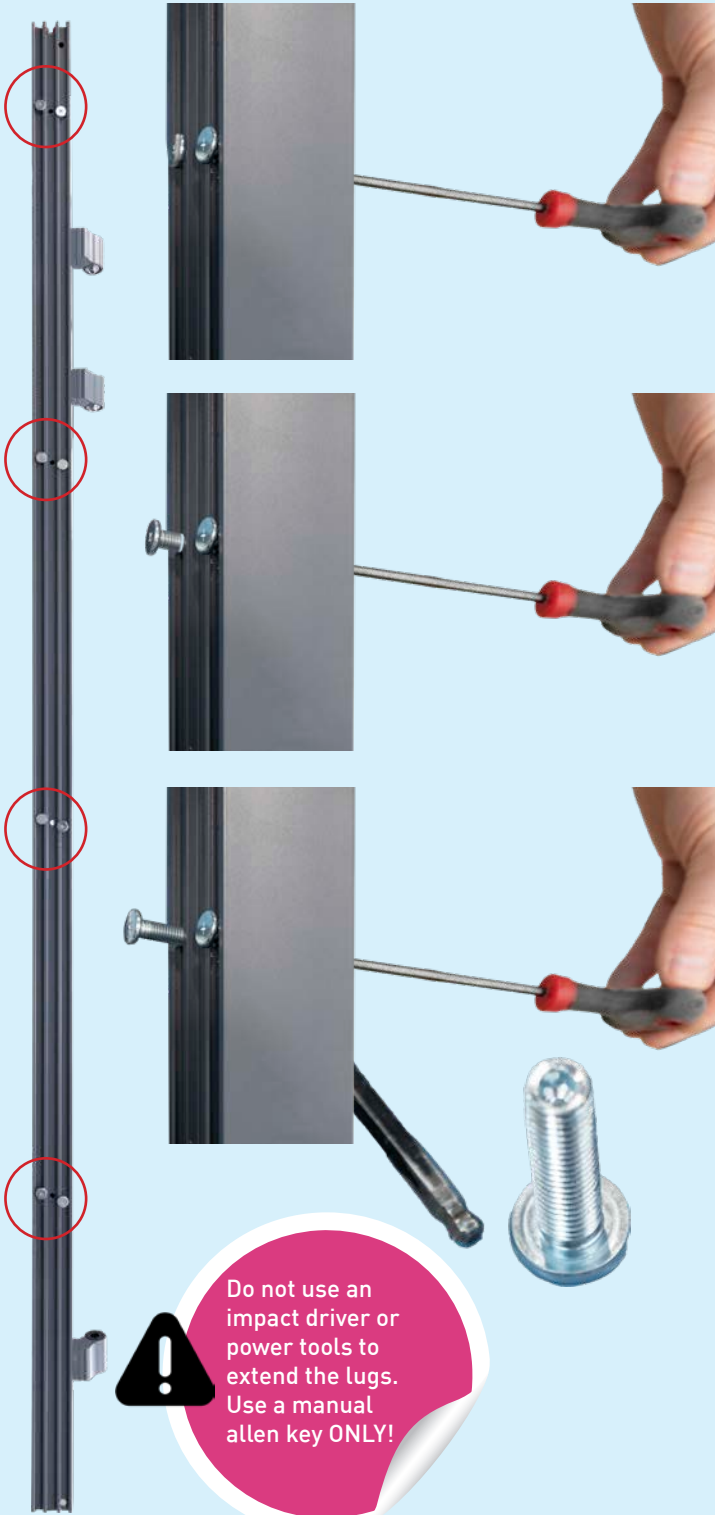

**Do not use an impact driver or power tools to extend the lugs. Use a manual allen key ONLY!**

If the pillars are not square use the wind-out lugs to ensure the frame is set at 90°.

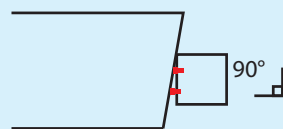

If the opening pillars are out of line, ensure the frame is not distorted.

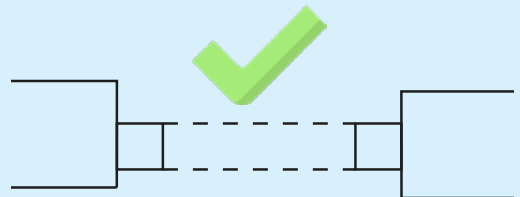
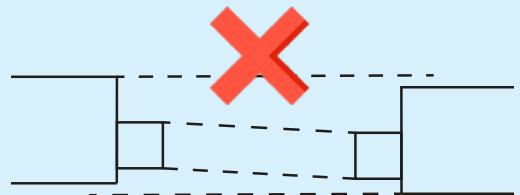

## LEAF ALIGNMENT

4.

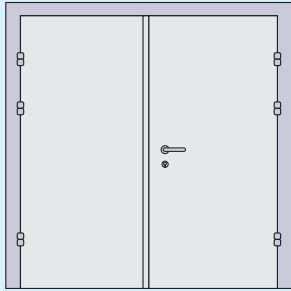

When the frame is set, close the door leaves and check alignment.



The top edges of each leaf should be horizontal and level with each other.



The door leaves also need to align vertically with the leading edges of each leaf aligned along their full length.



**If adjustment of door leaf alignment is required, manipulation of the frame setting is often sufficient to correct misalignment. Follow the guidance below.**

Spirit levels and even laser levels may show that the frame is well set and true, however over the length of the frame, even a slight variance at the frame is magnified at the door edge. 0.5mm out of true may show as several mm at the doors' leading edge or level.

Adjustment should be made by moving the frame leg in the planes as noted in 'D' and 'E'. Small changes in plane 'D' at the top or bottom of the frame will align the door edge vertically, whilst small changes in plane 'E' will align the leaf horizontally.

A combination of both will often provide the correct alignment. Both sides of the frame may require adjustment.

Open the door leaf, make the adjustments and close to check the door is hanging true.

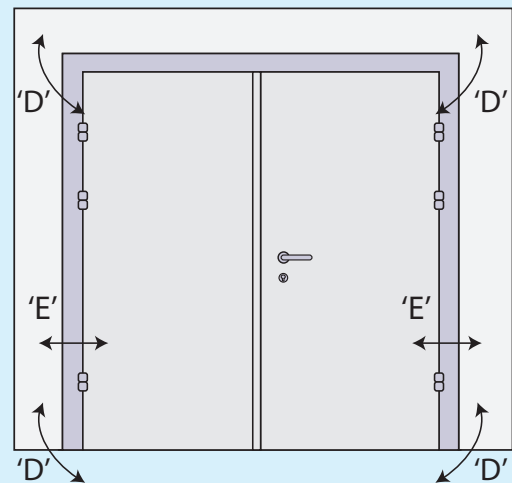

**If, after following the above guidance, further alignment is required, use the hinge adjustment to correct the leaf alignment.**

## HINGE ADJUSTMENT

Hinges can be adjusted vertically and horizontally in the plane of the edge to edge of the leaf.

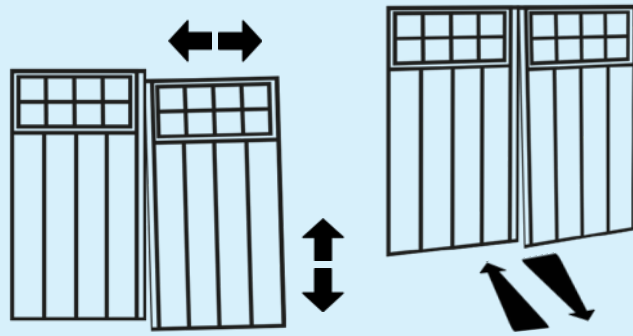

## VERTICAL HINGE ADJUSTMENT

The hinges are set to their lowest point for vertical alignment, allowing the hinges to be raised by up to 4mm.



1. Remove the bottom plug.



2. Open the door, loosen the M6x5 set screw (4mm allen key).

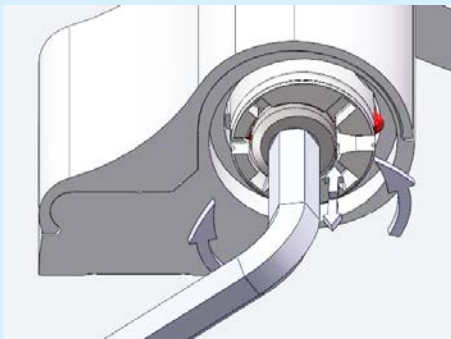

3. Close the door and use the M12 set screw (6mm allen key) to adjust.

An adjustment of up to 4mm is possible.

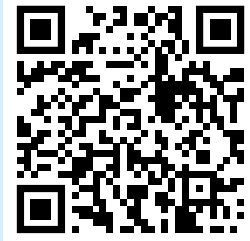

Scan the qr code to watch a short film on how to adjust hinges.

4. After adjustment, re-tighten the M6x5 set screw (4mm allen key) and refit the plug.

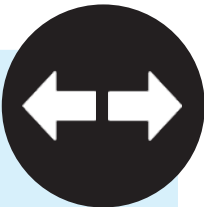

## LEAF-TO-FRAME CLEARANCE

The hinges are set to the mid-point for the horizontal position in the leaf edge to leaf edge plane of the door leaf, allowing for + or - 3.1mm of adjustment. This allows the door leaf to be made level.

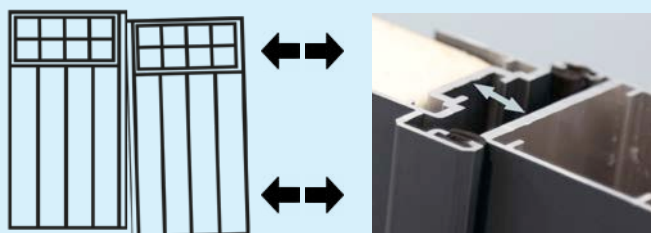

1. Remove the top plug.



2. Open the door, remove the M4 screw (3mm allen key).



Do not attempt to remove the hinge cover without releasing the set screw. Damage will occur!

3. Loosen the M6x5 set screw (4mm allen key).

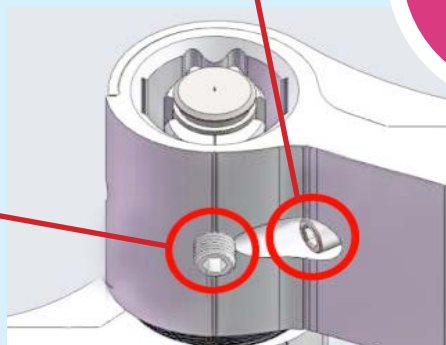

4. Close the door, remove the hinge cover and adjust.

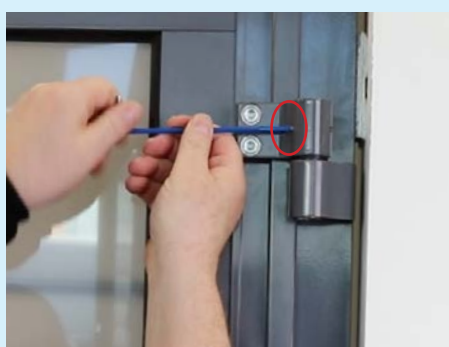
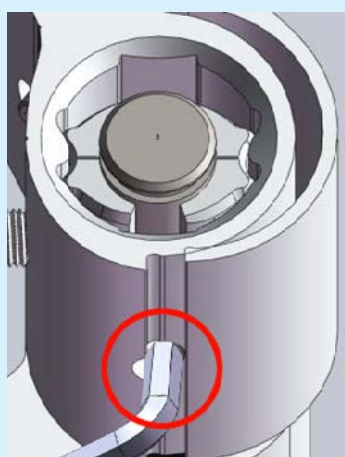

Scan the qr code to watch a short film on how to adjust hinges.

Adjustment options for leaf-to-leaf:

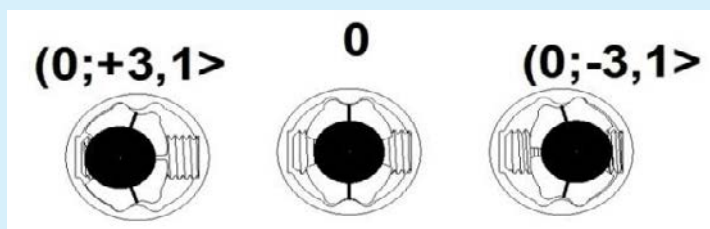

5. After adjustment, refit covers, insert and tighten the M4 screw (3mm allen key), re-tighten the M6x5 set screw (4mm allen key) and refit the plug.





## GASKET CLAMPING FORCE ADJUSTMENT

The hinges are set to the mid-point (0) for the horizontal position in the outer leaf-face to inner leaf-face plane of the door leaf. There are two selectable positions in each direction - see below.



Scan the qr code to watch a short film on how to adjust hinges.



1. Remove the bottom plug.

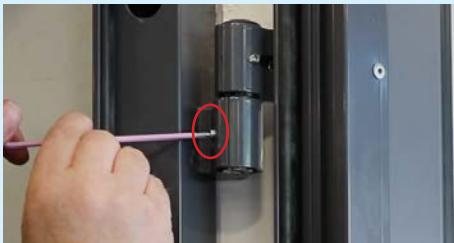

3. Open the door, loosen the M6x5 set screw (4mm allen key).



2. Close the door and remove the M12 set screw .



4. Insert the door key head and turn to adjust.

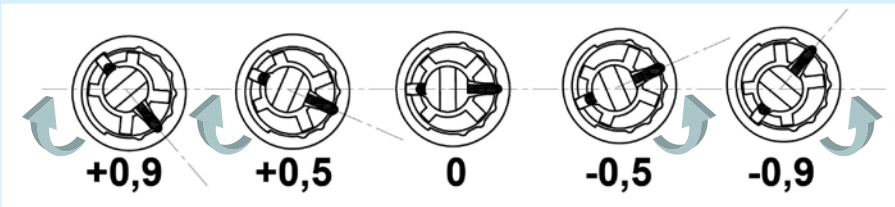

Use the door key head to increase or decrease the clamping force as shown left - two selectable points in each direction.

5. After adjustment, replace in the M12 set screw (6mm allen key) and tighten until a slight drag is noticed.

6. Tighten the M6x5 set screw (4mm allen key) and refit the plug.

## FIXING THE FRAME

5.

Using a 10mm bit, drill through the frame fixing pilot holes. With an 8mm bit, drill into the reveal and insert the appropriate fixing for the wall construction and tighten.

**When drilling ensure all parts of the door are protected from brick dust and other fragments.**

The supplied fixing straps can be used if fixing through the frame cannot be achieved.

We recommend a fixing at each hinge and two into the header as shown, as a minimum.

**! Do not fit the cover grommets in-case adjustment is required.**

After each fixing check the door alignment has not shifted and the frame has not been distorted.

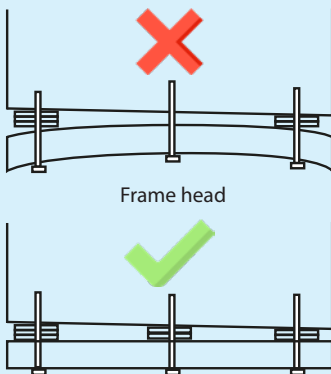
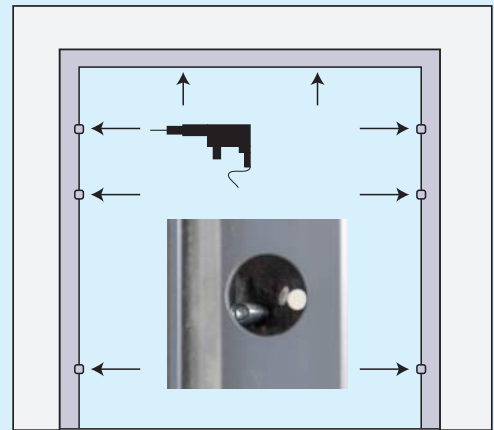

Frame head

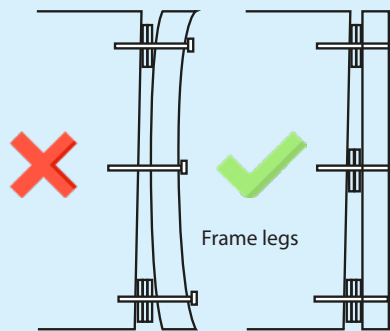

Frame legs



**If packers have been used, ensure each fixing point has packers to prevent the frame distorting when tightening fixings.**

## FITTING THE THRESHOLD

6.

**! A floor that is not level/flat across the full width of the opening will require packing to ensure correct installation of the threshold. If the threshold is not level or distorted, the alignment of the leaves with the seal will be compromised and weather performance degraded.**

The aluminium strip threshold should be positioned onto a layer of suitable mastic/sealant. Fix the threshold in place in at least four points with screws/plugs and drill a keep for the bottom shoot bolt on the inactive leaf to engage into.

Doors with a strip threshold have a blade seal to the bottom of the doors' leaves. The tip of the seal should be in contact with the threshold when fully closed. If it is not in contact, raise the threshold with a suitable packer along its full length to ensure the threshold is level and undistorted.

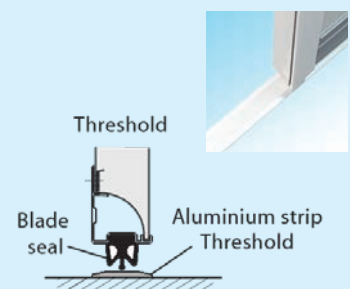

## ADJUSTING THE LATCH

7.

When the door is hanging correctly, check the lock keeps for alignment with the lock mortise and latch.

If there is too much play in the latching, use the adjusters directly above and below the latch keep to move the latch point for a snug fit when the door is closed.



## 8. ADJUSTING THE SHOOT BOLT KEEPS

If the shoot bolts on the inactive leaf do not hold the door leaf against the seal, the top shoot bolt keep can be adjusted by first loosening the screws.

Slide the keep plate to move the bolt location point in or out until a snug fit is achieved. After adjustment is complete, re-tighten the screws.

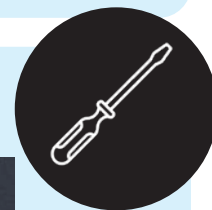

## 9. FITTING THE STAYS

With the door aligned and latching, attach the friction stay to the door frame using the self tapping screws provided and the pre-drilled holes.



**Check operation to ensure the stays operate and the door leaves do not strike the opening reveal.**

The friction of the stay can be adjusted by tightening or loosening the bolt with an adjustable spanner.



Friction  
adjustment  
bolt



10.

To finish, check the function of the door and locks now everything is in place and that compression seals are not caught or folded to ensure the best seal. Fit the grommets to cover the fixing holes.



Clean and dry the door thoroughly inside and out with warm soapy water to remove any grease, dust and metal fragments from the door (these will discolour the door finish if left on the door).

The door is now installed and should operate smoothly.

**! The door is supplied with 2 keys for the lock and these, along with the fitting instructions should be given to the end-user on handover.**

## OPERATION & FUTURE ADJUSTMENT

The door should always be opened active leaf first, inactive leaf second to the fully opened position with the stays engaged.

**“Throwing” the leaf open will result in potential damage to the door leaf and stays.**

**! The inactive leaf must always be secured with the top and bottom shoot bolts located to ensure correct alignment of the door leaf and a secure closure.**

No lubrication of the hinges is required, however a light spray oil should periodically be applied to the door stay mechanism. Alignment of the leaves can be adjusted using the procedure in section 4.



## DOOR CLEANING

**! At handover the door owner must be informed of the ongoing requirement for care and maintenance of the door.**

The door should be washed with a car shampoo or similar, every two months to prevent the build up of dirt, salt, grit and other corrosive substances. If the door is in an area prone to coastal corrosion from airborne salts, the door should be cleaned monthly. Furthermore, cleaning operating gear with a cloth soaked in a light oil will help to protect your door from corrosion – it must be accepted that salt air is very aggressive and extra care is required.

No caustic, abrasive or corrosive chemicals and substances, flood water, water runoff, or runoff from lead, copper or galvanic metal flashing should be allowed to come into contact with the door.

Ash, cement, dust, animal waste, or foreign substances should be removed immediately. Failure to ensure the door is cleaned and maintained as described will invalidate the doors' warranty.





## WHAT CAN I EXPECT FROM MY DOOR?

GDO side hinged garage doors and personnel doors are designed to provide access to and from a garage space.

GDO side hinged garage doors and personnel doors are not front doors!

Front doors must be compliant to the British Standard for pedestrian doorsets BSEN14351-1. Garage doors must be compliant to the British standard for garage doors BSEN13241-1

As a garage doors' primary function is to allow vehicular access and personnel access to a garage, they are designed to conform to different requirements when compared to a front door, which provides access to a living space.

It is important to note that the stated performance of our doors (made in the Declaration of Performance for GDO side hinged garage doors and personnel doors as part of the requirement of the British Standard for Garage doors) is lower than that required for a front door, but you can't get a vehicle through a front door! Most garages do not require the performance of a front door as they are unheated spaces designed to store a vehicle.

Below are the key points that you must accept regarding the performance of our doors. It's important that you take them on-board, as we want to be as transparent and honest about what you can reasonably expect from the products we sell.

## LIGHT, DRAFTS & WATER INGRESS

When the door is closed, light ingress is to be expected. The door seals are reasonably effective at stopping light passage but will not eliminate it. This will be more pronounced generally where seals meet and particularly in corners. Where light can get in, so can a draft. With a well installed door that has seals in good condition, drafts will be minimal but the door is not sealed completely.

Under normal weather conditions water ingress should also be minimal, but you may experience some ingress, as with light and drafts, where seals meet and in corners. Under extreme conditions; driving rain and high winds, ingress can be expected to increase. Never jet wash a door, not only may it damage the finish but it can force open seals causing water ingress.

The threshold is a point where water ingress may occur. Gaps between the bottom seal and the threshold arising from a poorly fitted or uneven threshold will allow water ingress. If rain runoff is able to collect and pool at the bottom of a door instead of draining away from the door into a drainage channel, water ingress may occur. Fitting the door onto a stepped rebate behind a drainage channel is often effective in greatly reducing the likelihood of water ingress.

## THERMAL PERFORMANCE

GDO side hinged garage doors and personnel doors have not been tested for thermal performance. The declaration of performance for GDO side hinged garage doors and personnel doors, as part of the requirement of the British Standard for Garage doors (EN13241-1), states, "No Performance Determined". This means we make no claims about the insulating properties of our door and you must decide, knowing this, if they are suitable for your needs.

GDO side hinged garage doors and personnel doors are made from aluminium hollow-section profiles and double walled steel panel sections filled with a rigid polymer foam. The door panel sections have been tested but not as a complete door and have a U value of 0.56 W/m<sup>2</sup>K





