



Side Hinged Garage Doors



Traditional



TRADITIONAL - classic design door.

Replace door but not a style!

Double glazed panel with clear, matt, "frosted" or tinted glass.

Any RAL Classic or "Golden Oak", "Old Oak", "Dark Oak" or "Rosewood" colour.



Flush

Flush design in either woodgrain or stucco finish offers a classic look which suits traditional and modern properties alike. The door can be personalized with attractive window options. You can choose vertical or horizontal panel layout and any colour you like.







Slick

No ribs, no embossing - just a smooth panel. But looks great! Slick design offers exceptional range of colours. In combination with stainless steel windows or appliqués and metallic finish your garage door can look million worth.



Rib

The simplistic Rib design available in both horizontal and vertical versions, combined with various woodgrain or stucco colours, makes it a popular choice.

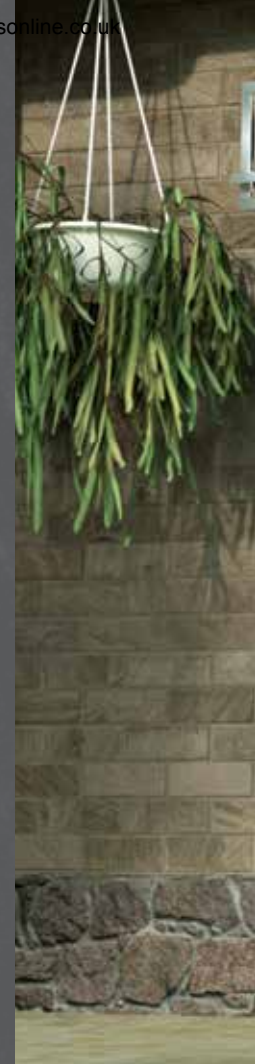





Midrib

Midrib resembles solid timber planks and is available in various finishes and colours including popular smooth metallic.



Georgian (Cassette)

Good old Georgian design.



Modern

Modern design door can significantly improve your house kerb appeal and increase value. Just imagine and we will try to turn your dreams in to reality.



Diamond

Diamond design door will make your home 'sweet home'.



Chevron

The Chevron is uncomplicated traditional design available in various finishes and colours. The traditional Chevron design doors are made of Rib design panels. Other panel designs and combinations can be used as well.



Stainless steel windows will decorate any door. Play with sizes, shapes, layout.





Stainless steel appliques can make your door really different and special. Choose from standard appliqué catalogue or create your own. Appliqués combined with stainless steel windows can create a stunning effect.



Think outside the box!
Design, layout, colour – sky is the limit.



Custom split, Intergrated letter-box



Slim-line



Customised 'Modern' design



Bi-folding leaves



Custom shape frame, Retro design



Custom design clad with okoume

The door has improved tube rubber sealing all around perimeter and between leaves.



Hinge bolts
Higher burglar resistance.
(Additional option)



Installation is fast and easy. All fixings included.



Standart S5 Sloping threshold made of zinc coated steel profile. Optional - stainless steel plated. S1 & S4 thresholds available as well.

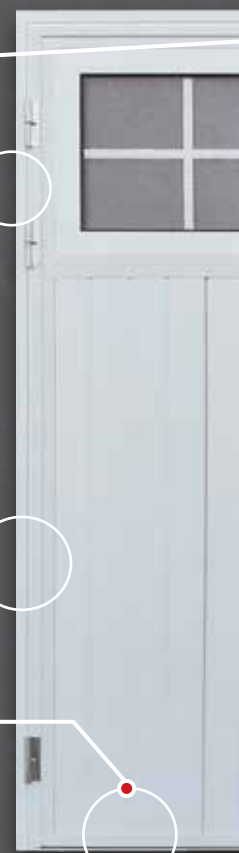
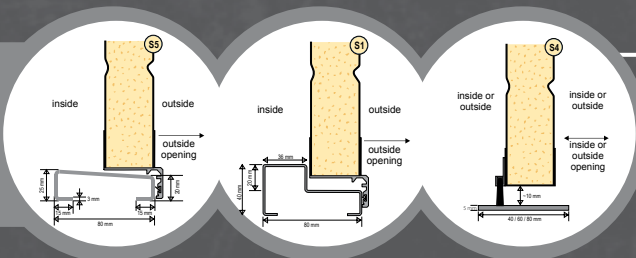



Scratch proof energy efficient double glazing. Acrylic glass.



First door leaf can be left-hand or right-hand swing. The door split can be 1/2 : 1/2, 1/3 : 2/3 or any other reasonable proportion. Max leaf width 1.5 metre.

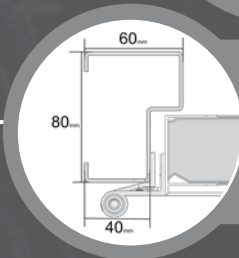

Zinc coated, robust and maintenance free steel frame. Painted same colour as the door or different if specified.

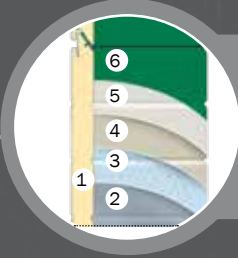

Energy efficient insulated door panels. Double steel skin filled with freon free PU foam: 1- 40mm thick foam; 2- steel; 3- zinc; 4- primer; 5- finish coating; 6- colour.

FRAME MOULDINGS

This option allows door to be fitted flush with the front wall hiding any small gaps or distressed brickwork. Same colour as frame. On left side frame with moulding on right - without moulding.



with moulding



without moulding

FRAME PROFILE CROSS-CUT VIEW

As standard - same colour as door. On request can be painted any colour.

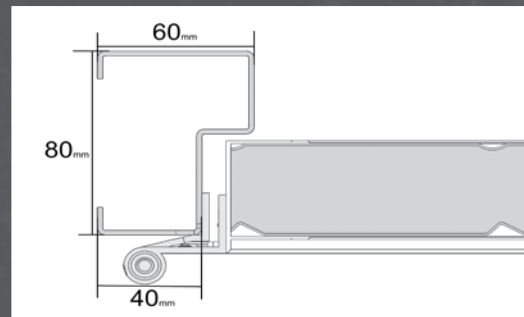

22

HANDLE & ESCUTCHEON OPTIONS

White, black, aluminium are the standard choice. Custom colour on request.



PULL HANDLES (OPTIONAL)

Round & Square Bar Handles
Height 500 - 1800 mm



Knob Handle
Diameter Ø50 mm



Additional options

ESPAGNOLETTE LOCK

Optional espagnolette lock to keep second leaf in closed position. Designed to make opening the second door leaf effortless.



DOOR STAYS

Door stays keep door leaf in open position.



Adjustable leaf opening angle 90 - 140 degrees.



STAINLESS STEEL COVER FOR S5 THRESHOLD

Gives more beauty to side hinged door and protects threshold paint from wearing off.



Windows

DOUBLE GLAZED ALUMINIUM PANEL

Painted any colour (can be different from door colour).
Scratch-proof double glazing can be clear, matt, "frosted".
"Cross" decor available – same as panel colour.



24

clear

"frosted"

matt

GLAZED PANEL ADDITIONAL OPTIONS

"Cross" decor

FV-BS

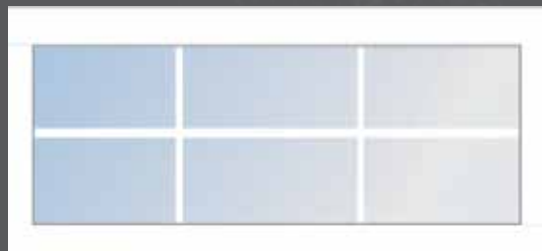

STAINLESS STEEL WINDOWS:

SQUARES

MINI 154 x 154 mm



MIDI 234 x 234 mm



MAXI 314 x 314 mm



PORTHOLES

MINI Ø 150 mm



MIDI Ø 230 mm



MAXI Ø 310 mm



WINDOW WITH TRIPLEX DOUBLE GLAZING.

804 x 154 mm

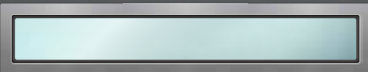

Window frame painted any colour.



PLASTIC WINDOWS:

SCRATCH PROOF DOUBLE GLAZING.

488 x 322 mm white

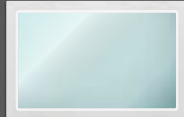

488 x 322 mm black

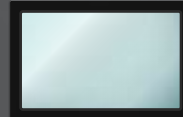

DECOR FOR PLASTIC WINDOWS

CROSS



SUNRISE



Frame & Handing options

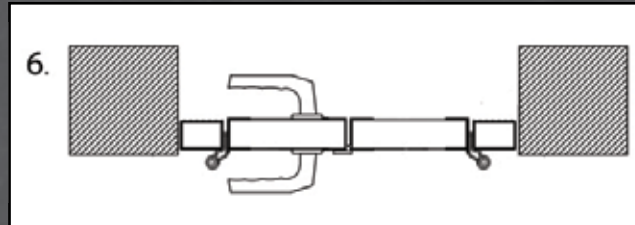
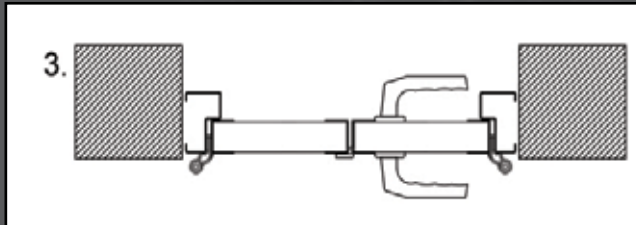
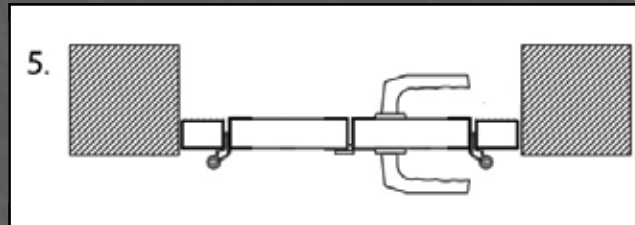
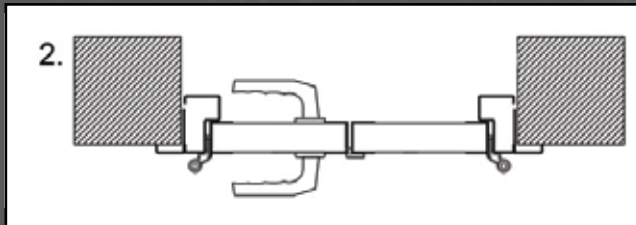
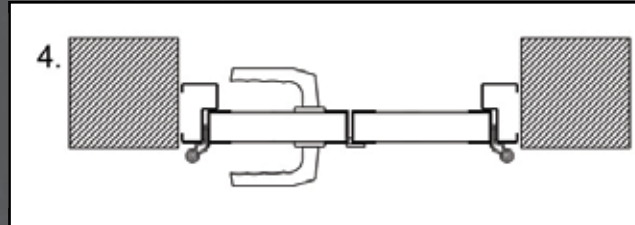
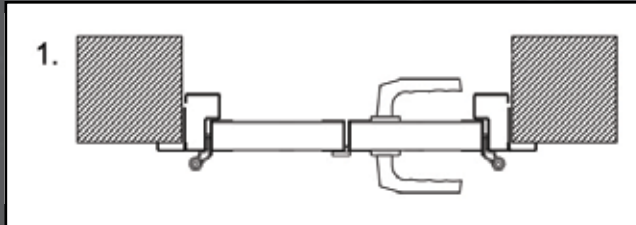

PET FLAP



Garage door can be with integrated pet flap.

MAIL BOX



Have garage door facing the street - integrated mail box can be an option.

VENTILATED



Doors with perforated steel sheets to ensure necessary air circulation.